

Introduction to UMTS Device Testing

Transmitter and Receiver Measurements for WCDMA Devices

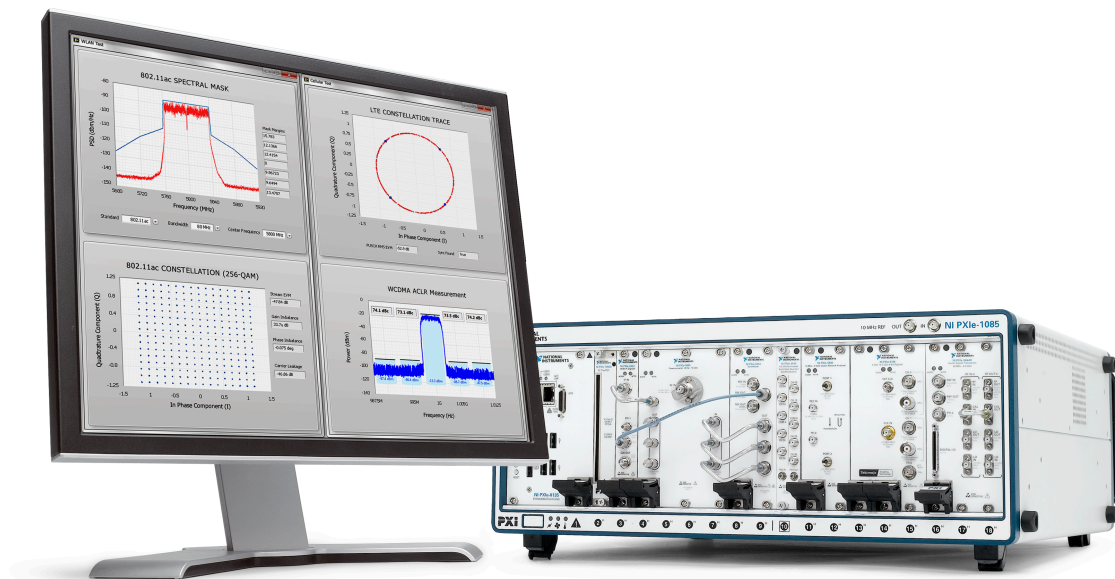

Table of Contents

1. UMTS: from WCDMA to HSPA+	3
2. Overview of the UMTS Standard.....	5
Bands and Frequency Definitions.....	5
Wideband Code Division Multiple Access Technology.....	8
Modulation Schemes.....	11
MIMO and Carrier Aggregation.....	12
Physical and Logical Channels.....	14
UMTS Physical Layer Testing.....	18
3. WCDMA Transmitter Measurements.....	19
Transmitter Test Setup Configuration.....	19
Power Measurements.....	20
Uplink Output Power Dynamics.....	23
Spectrum Measurements.....	31
Occupied Bandwidth Measurement.....	32
Spectrum emission mask.....	33
Adjacent Channel Leakage Ratio (ACLR).....	34
Spurious Emissions.....	37
Transmit Intermodulation.....	37
Transmit Modulation Quality.....	39
Frequency Error.....	39
Error Vector Magnitude (EVM).....	40
Peak Code Domain Error.....	43
4. WCDMA Receiver Characteristics.....	45
Measuring Receiver BER.....	46
Reference Sensitivity Level.....	47
Maximum Input Level.....	48
Adjacent Channel Selectivity (ACS).....	49
Blocking Characteristics.....	50
In-Band Blocking.....	52
Out-of-Band Blocking.....	53
Narrowband Blocking.....	55
Spurious Response.....	56
Intermodulation Characteristics.....	58
Spurious Emissions.....	60
5. References.....	62

Introduction to UMTS Device Testing

Transmitter and Receiver Measurements for WCDMA Devices

1. UMTS: from WCDMA to HSPA+

3G mobile communications has its roots in a project set up initially in 1985 by the International Telecommunication Union (ITU) called International Mobile Telecommunications 2000 (IMT-2000). For a number of years, the European Communications had been sponsoring research that resulted in a number of key technologies (Direct Sequence - CDMA) in UMTS. In parallel, other regions also did a significant amount of research on DS-SS-CDMA. For example, NTT DoCoMo in Japan developed the first experimental network of DS-SS-CDMA in the late 1990's. IMT-2000 identified various potential radio interfaces based on time division multiple access (TDMA), frequency division multiple access (FDMA) and code division multiple access (CDMA). This parallel research eventually led to regional development of CDMA technologies such as IS-136 in the United States and TD-SS-CDMA in China.

The third-generation partnership project (3GPP), established in 1998, was formed with the charter of creating a global application 3G mobile communications system. The 3GPP included organizational partners from Asia, Europe and North America, and included representatives of regional standards organizations such as the Alliance for Telecommunications Industry Solutions (ATIS) in USA, the European Telecommunications Standards Institute (ETSI) in Europe, the Association of Radio Industries and Businesses (ARIB) and the Telecommunication Technology Committee (TTC) in Japan, the China Communications Standards Association (CCSA) in China, and the Telecommunication technology Association (TTA) in Korea.

The 3GPP successfully released their first third generation 3G cellular standard as part of 3GPP Release 99 in 2000. The new standard was known as Universal Mobile Telecommunications Systems (UMTS). UMTS was based on the wideband code division multiple access (WCDMA) air interface and as a result, the terms 'UMTS' and WCDMA are often used interchangeably to refer to 3G.

The WCDMA air interface is fundamentally a spread spectrum modulation technique that uses a channel bandwidth that is much greater than that of the transmission data. WCDMA is a wideband Direct-Sequence Code Division Multiple Access (DS-SS-CDMA) system in which user information bits are spread over a wide bandwidth by multiplying the user data with quasi-random bits derived from Walsh-Hadamard code. Instead of each connection being granted a dedicated frequency channel as in GSM, multiple UMTS devices share common uplink and common downlink channels. Transmissions from both the handset and the base station are orthogonal via a spreading code, which delineates who the transmission is intended for, and who the transmission is coming from.

UMTS boasts increased capacity over GSM for high bandwidth applications and features, which includes enhanced security, quality of service (QoS), multimedia support, and reduced latency. UMTS was also designed to use a core network derived from that of GSM, which ensures backward compatibility of services and allows seamless handover between GSM access technology and UMTS. UMTS operators can use a common core network that supports multiple radio-access networks, including GSM, EDGE, WCDMA, HSPA as well as evolutions of these technologies. This provides the operators flexibility in providing different services across their coverage areas.

Evolution of UMTS

Although the transmissions defined by the UMTS standard originally used QPSK modulation, demands for higher data rates introduced new technologies such as higher order modulation schemes, multiple-input multiple-output (MIMO), and eventually carrier aggregation. The maximum uplink (UL) and downlink (DL) data rates between GSM, GPRS, EDGE, UMTS and UMTS evolutions are shown in **Table 1.1**.

Introduction to UMTS Device Testing

Transmitter and Receiver Measurements for WCDMA Devices

Standard	3GPP Release	Year	Peak DL Speed	Peak UL Speed
GSM	Release 96	1997	43.2 kbps	14.4 kpps
GPRS	Release 97	1998	80 kbps	40 kbps
EDGE	Release 98	1999	296 kbps	118.4 kbps
UMTS WCDMA (FDD and TDD)	Release 99	2000	384 kbps	384 kbps
HSDPA	Release 5	2002	1800 kbps	384 kbps
HSUPA	Release 6	2004	3.6-7.2 Mbps	5.76 Mbps
HSPA+	Release 7 and 8	2007/2008	28-42 Mbps	11.5 Mbps

Table 1.1 Performance Evolution of 3GPP standards

Table 1.1 shows that the initial UMTS network deployment was based on 3GPP Release 99 specifications, which included voice and data capabilities. 3GPP Release 5 introduced High Speed Downlink Packet Access (HSDPA) in 2002. HSDPA used higher order modulation schemes (16-QAM) to downlink transmissions but did not modify the uplink. In 2004, 3GPP Release 6 introduced Enhanced Up Link (UL) - also referred to as High Speed UL Packet Data Access (HSUPA). HSUPA improved data rates through more efficient spectrum utilization and lower latency. The combination of HSDPA and HSUPA technologies is referred to simply as High Speed Packet Access (HSPA).

The next evolution of the UMTS standard was HSPA evolution, which is also known as HSPA+ or evolved HSPA. HSPA+ brings improved support and performance for real-time conversational and interactive services such as push-to-talk over cellular, picture and video sharing, and video and voice over internet protocol (VoIP). HSPA+ was first introduced in 2007 with 3GPP Release 7, though the HSPA+ term is used to describe new features introduced in all later versions of the UMTS standard (3GPP Release 7 and later). HSPA+ introduced new downlink features including the 64-QAM modulation scheme and multiple-input-multiple-output (MIMO) antenna technology. In the uplink, HSPA+ added the 16-QAM modulation scheme. The standardization of HSPA+ has continued through to Release 11 and continues to push HSPA peak data rates. In fact, future releases of the UMTS standard will likely utilize some of the techniques developed for Long Term Evolution (LTE) - extending the life of UMTS networks.

2. Overview of the UMTS Standard

The UMTS and WCDMA specifications are a joint standardization project of Europe, Japan, Korea, USA and China. As a result, UMTS allows both Frequency Division Duplex (FDD) and Time Division Duplex (TDD) for operating with paired and unpaired bands respectively. The possibility to operate in either FDD or TDD mode allows for efficient utilization of the available spectrum and depends on a wide range of regionally-varying spectrum scenarios. The key differences between UMTS FDD and TDD are outlined in **Table 2.1**.

Parameter	UMTS-TDD	UMTS FDD
Multiple access method	TDMA, CDMA	CDMA
Duplex method	TDD	FDD
Channel spacing	1.6 MHz, <i>Typical</i> 5 MHz, <i>Optional</i>	5 MHz
Carrier chip rate	1.28 Mcps, <i>Typical</i> 3.84 Mcps, <i>Optional</i>	3.84 Mcps
Frame length	10 ms	10 ms
Detection	Coherent based on midamble	Coherent based on pilot symbols
Spreading factors	1 .. 16	4 .. 512

Table 2.1 Differences and Similarities Between UMTS TDD and FDD

Table 2.1 shows that the physical layer transmissions are quite similar between TDD and FDD modes – although this document will mainly focus only on testing for FDD. The chip rate of 3.84 Mcps produces a transmission bandwidth of approximately 5 MHz. DS-SS systems with a bandwidth of about 1 MHz, such as IS-95, are commonly referred to narrowband CDMA system. The inherently wide bandwidth of WCDMA supports higher user data rates.

Bands and Frequency Definitions

The radio interface of UMTS is known as the UMTS Terrestrial Radio Access (UTRA) and the 3GPP defines a number of paired frequency bands in which a UMTS terminal can operate. The operating bands are specified according to the center frequency at which the user equipment (UE) either transmits or receives data. These bands are described in **Table 2.2**.

Introduction to UMTS Device Testing

Transmitter and Receiver Measurements for WCDMA Devices

Operating Band	UL Frequencies UE transmit, Node B receive	DL frequencies UE receive, Node B transmit	TX-RX frequency separation	ARFCN Range UL	ARFCN Range DL
I	1920 - 1980 MHz	2110 - 2170 MHz	190 MHz	9612 to 9888	10562 to 10838
II	1850 -1910 MHz	1930 - 1990 MHz	80MHz	9262 to 9538 additional 12, 37, 62, 87, 112, 137, 162, 187, 212, 237, 262, 287	9662to 9938 additional 412, 437, 462, 487, 512, 537, 562, 587, 612, 637, 662, 687
III	1710 -1785 MHz	1805 - 1880 MHz	95 MHz	937 to 1288	1162 to 1513
IV	1710 -1755MHz	2110 - 2155MHz	400 MHz	1312 to 1513 additional 1662, 1687, 1712, 1737, 1762, 1787, 1812, 1837, 1862	1537 to 1738 additional 1887, 1912, 1937, 1962, 1987, 2012, 2037, 2062, 2087
V	824 - 849MHz	869 - 894MHz	45 MHz	4132 to 4233 additional 782, 787, 807, 812, 837, 862	4357 to 4458 additional 1007, 1012, 1032, 1037, 1062, 1087
VI	830 - 840 MHz	875 - 885 MHz	45 MHz	4162 to 4188 additional 812, 837	4387 to 4413 additional 1037, 1062
VII	2500 - 2570 MHz	2620 - 2690 MHz	120 MHz	2012 to 2338 additional 2362, 2387, 2412, 2437, 2462, 2487, 2512, 2537, 2562, 2587, 2612, 2637, 2662, 2687	2237 to 2563 additional 2587, 2612, 2637, 2662, 2687, 2712, 2737, 2762, 2787, 2812, 2837, 2862, 2887, 2912
VIII	880 - 915 MHz	925 - 960 MHz	45 MHz	2712 to 2863	2937 to 3088
IX	1749.9 - 1784.9 MHz	1844.9 - 1879.9 MHz	95 MHz	8762 to 8912	9237 to 9387
X	1710 - 1770 MHz	2110 - 2170 MHz	400 MHz	2887 to 3163 additional 3187, 3212, 3237, 3262, 3287, 3312, 3337, 3362, 3387, 3412, 3437, 3462	3112 to 3388 additional 3412, 3437, 3462, 3487, 3512, 3537, 3562, 3587, 3612, 3637, 3662, 3687
XI	1427.9 - 1447.9 MHz	1475.9 - 1495.9 MHz	48 MHz	3487 to 3562	3712 to 3787

Table 2.2 3GPP Designated FDD Frequency Bands for UTRA

A typical handset supports a certain subset of the bands in **Table 2.2** depending on the desired market, since supporting all would be challenging for the transceiver especially for front-end components such as power amplifiers, filters, duplexers, and antennas. As a result of the band allocations illustrated in **Table 2.2**, the frequency

Introduction to UMTS Device Testing

Transmitter and Receiver Measurements for WCDMA Devices

spacing between uplink and downlink bands varies according to the bands supported by the device. Although the UMTS standard was originally designed with bands I and II, subsequent 3GPP releases have defined additional bands.

In all bands, the nominal channel spacing is 5 MHz with each channel's center frequency an integer multiple of 200 kHz, but this can be adjusted to optimize performance in a particular deployment scenario by a minimum of 4.4 MHz. Channel numbers can be defined by the UTRA Absolute Radio Frequency Channel Number (UARFCN). For each operating band, the values of the UARFCN are defined in **Equation 2.1** and **Equation 2.2**.

$$N_U = 5 \times (F_{UL} - F_{UL_Offset}), \text{ for the carrier frequency range } F_{UL_low} \leq F_{UL} \leq F_{UL_high}$$

Equation 2.1. Uplink UARFCN as a Function of Frequency Band

$$N_D = 5 \times (F_{DL} - F_{DL_Offset}), \text{ for the carrier frequency range } F_{DL_low} \leq F_{DL} \leq F_{DL_high}$$

Equation 2.2. Downlink UARFCN as a Function of Frequency Band

In **Equation 2.1** and **Equation 2.2**, N_U and N_D are the UARFCN for the uplink and the downlink. For example, consider the UARFCN calculation for channels in operating band II in North America. In order to calculate UARFCN, you must first determine characteristics such as the high and low uplink and downlink frequencies as specified in **Table 2.3**.

Band	UPLINK (UL) UE transmit, Node B receive			DOWNLINK (DL) UE receive, Node B transmit		
	UARFCN formula offset F_{UL_Offset} [MHz]	Carrier frequency (F_{UL}) range [MHz]		UARFCN formula offset F_{DL_Offset} [MHz]	Carrier frequency (F_{DL}) range [MHz]	
		F_{UL_low}	F_{UL_high}		F_{DL_low}	F_{DL_high}
I	0	1922.4	1977.6	0	2112.4	2167.6
II	0	1852.4	1907.6	0	1932.4	1987.6
III	1525	1712.4	1782.6	1575	1807.4	1877.6
IV	1450	1712.4	1752.6	1805	2112.4	2152.6
V	0	826.4	846.6	0	871.4	891.6
VI	0	832.4	837.6	0	877.4	882.6
VII	2100	2502.4	2567.6	2175	2622.4	2687.6
VIII	340	882.4	912.6	340	927.4	957.6
IX	0	1752.4	1782.4	0	1847.4	1877.4
X	1135	1712.4	1767.6	1490	2112.4	2167.6
XI	733	1430.4	1445.4	736	1478.4	1493.4

Table 2.3 UARFCN Definition¹

¹ 3GPP TS 34.121, Section 4.4

Table 2.3 shows that channels in Band II have the following definitions:

$$\begin{aligned}F_{UL_Offset} &= F_{DL_Offset} = 0 \\F_{UL_low} &= 1852.4 \text{ MHz} \\F_{UL_high} &= 1907.6 \text{ MHz} \\F_{DL_low} &= 1932.4 \text{ MHz} \\F_{DL_high} &= 1987.6 \text{ MHz}\end{aligned}$$

You can calculate the corresponding UARFCN number (N_U) for uplink and downlink channels based on center frequency by applying **Equation 2.1** and **Equation 2.2**. For example, an uplink transmission at a center frequency of 1852.4 MHz would have the following UARFCN definition:

$$N_U = 5 \times (1852.4 \text{ MHz} - 0) = 9262$$

Similarly, a downlink transmission at a center frequency of 1987.6 MHz would have the following UARFCN definition:

$$N_U = 5 \times (1987.6 \text{ MHz} - 0) = 9938$$

You can use Equation 2.1 and Equation 2.2 to calculate the UARFCN number for any channel.

Wideband Code Division Multiple Access Technology

Spread spectrum communication systems have been in existence for decades. They are used in areas where the need for signals displaying anti-jam and low probability-of-intercept characteristics is paramount. Thus, they have been typically designed to be wideband, and those that employed direct sequence (DS) to achieve multiple access capability were the original forerunners of WCDMA. CDMA is based on direct sequence spread spectrum (DSSS), which utilizes a unique “spreading code” and applies it to a transmitted signal. In a spread spectrum system, the processing gain is the ratio of the spread bandwidth to the unspread bandwidth, which can be calculated using **Equation 2.3** below.

$$\text{Processing gain} = 10 \log \left(\frac{\text{Chip rate}}{\text{Bit rate}} \right)$$

Equation 2.3. Processing Gain of a CDMA Signal.

Although the spreading code increases the bandwidth of the transmission, it also enables the channelization of the transmission. **Figure 2.1** shows that applying a spreading code spreads the signal in the frequency domain and as a result, we refer to DSSS and CDMA as spread spectrum techniques.

Introduction to UMTS Device Testing

Transmitter and Receiver Measurements for WCDMA Devices

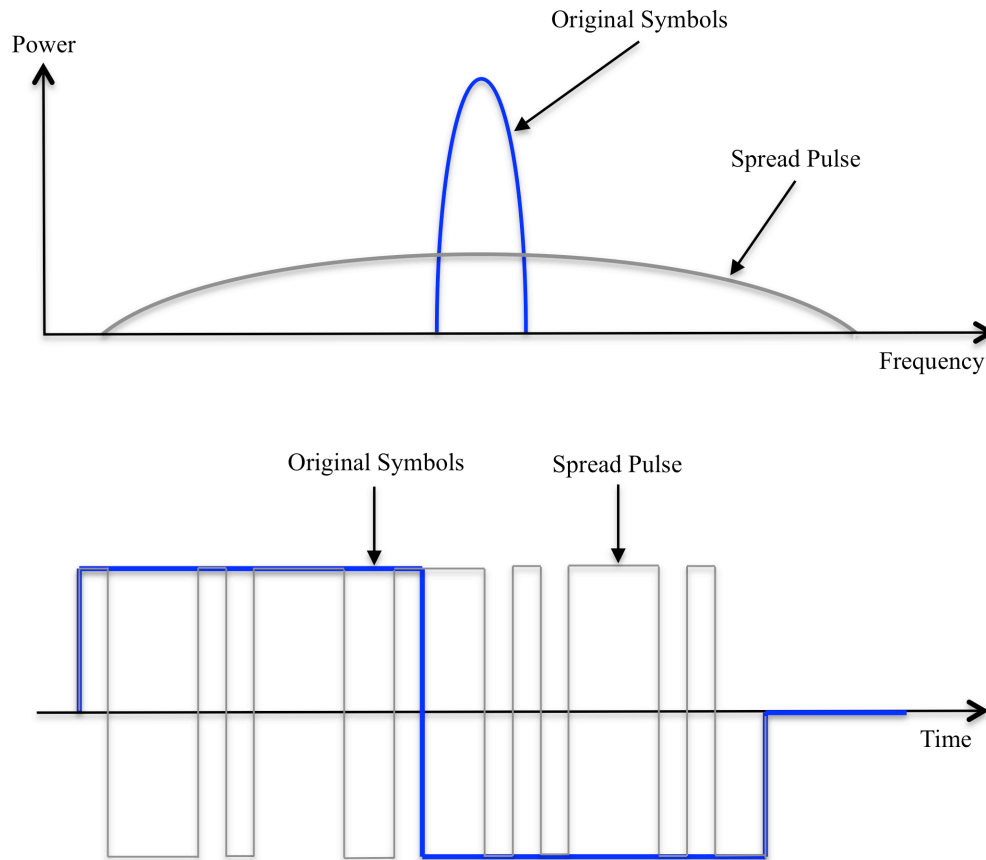

Figure 2.1. CDMA in the Time and Frequency Domain.

In order to demodulate a CDMA transmission, the receiver applies the same spreading code used in the transmission in order to demodulate the signal. This is illustrated in **Figure 2.2**.

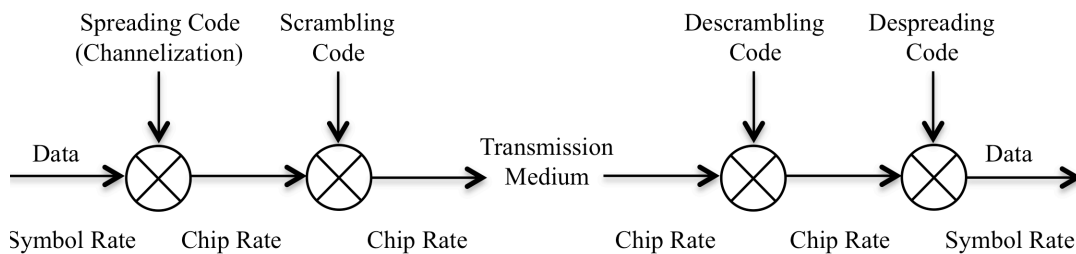

Figure 2.2. Processing of a CDMA signal

Applying spread spectrum modulation techniques to cellular communications allows for multiple users to share common spectrum. In addition, the transmitter encodes each channel in such a way that a decoder with the spreading code can pick out the wanted signal from other signals using the same band.

Introduction to UMTS Device Testing

Transmitter and Receiver Measurements for WCDMA Devices

Channelization codes used in UMTS are based on orthogonal variable spreading factor (OVSF) techniques for downlink transmission. The use of OVSF codes allows for the use of spreading codes of varying lengths while still allowing for orthogonality between each spreading code. Because the spreading code length is variable, the base station can therefore adjust the robustness of the transmission according to the channel conditions. For example, a shorter spreading code (with lower robustness but higher data rates) might be desirable for a handset that is close to the base station. By contrast, a longer spreading code (with higher robustness and lower data rates) might be desirable for a handset that is farther from the base station. The code tree in **Figure 2.3** defines the OVSF codes.

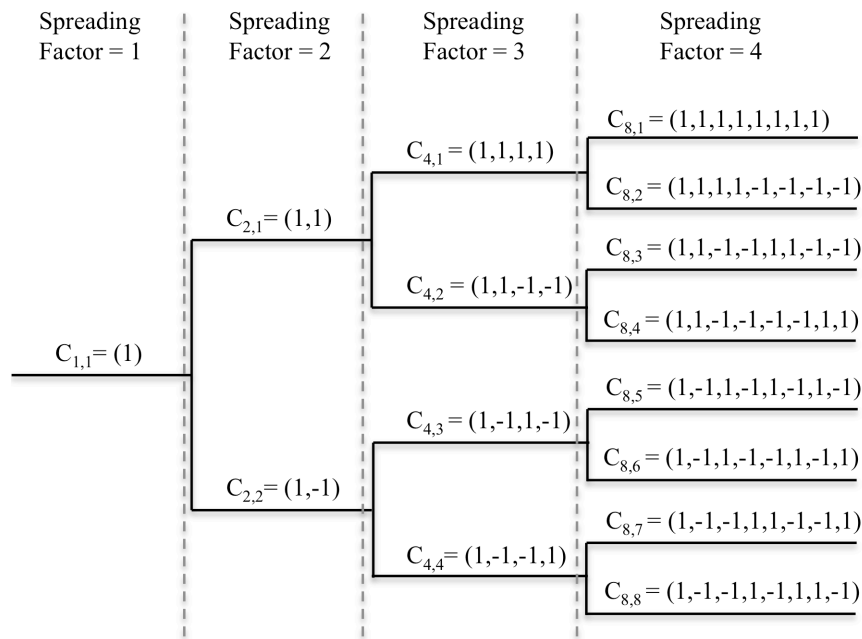

Figure 2.3. Code tree for generation of orthogonal variable spreading factor (OVSF) codes

Figure 2.3 uniquely describes the channelization codes as $C_{SF,k}$, where SF is the spreading factor of the code and k is the code number, $0 \ll k \ll SF-1$. Each level in the code tree defines channelization codes for a given spreading factor; a code in the tree is orthogonal to all other codes except for those that are below it.

Synchronization between each channel is required to preserve orthogonality between each channel. While synchronization is easy to achieve in the downlink, because all channels are transmitted by a common radio, this is not the case in the uplink. In the uplink, challenges with synchronizing receivers and varying distances from the handset to the base station make channel synchronization much more challenging. As a result, uplink transmissions are designed such that base stations can still demodulate the transmissions even if transmissions between multiple handsets are not orthogonal.

Power Statistics

Finally, observe that the number of channels supported in a downlink transmission has a significant impact on the peak to average power ratio (PAPR) of the signal. For example, transmissions with a large number of channels will produce a scenario where power from each channel will constructively or destructively interfere. Thus,

Introduction to UMTS Device Testing

Transmitter and Receiver Measurements for WCDMA Devices

transmissions with a large number of channels will have a higher PAPR than those with a small number of channels. **Table 2.5** compares PAPR characteristics of a wide range of downlink signal configurations.

Signal Type	Typical PAPR (dB)
Test Model 1 (4 DPCH)	10.8
Test Model 1 (64 DPCH)	11.5
Test Model 2	9.2
Test Model 3 (32 DPCH)	12.7

Table 2.5 PAPR of Various UMTS Downlink Test Signals

Table 2.5 illustrates that the number of channels and the modulation scheme both have a significant impact on the PAPR of the downlink waveform.

Modulation Schemes

Modern implementations of UMTS use various modulation schemes to vary the data rate of a physical channel. Transmissions defined by the UMTS standard originally used the QPSK modulation scheme. However, demands for higher data rates pushed future revisions of the standard to higher order modulation schemes. In 2002, 3GPP Release 5 introduced High Speed Down Link (DL) Packet data Access (HSDPA). This evolution introduced the 16-QAM modulation scheme to downlink transmission, although it still used QPSK for uplink transmissions. **Figure 2.5** illustrates a constellation diagram for a 16-QAM symbol map.

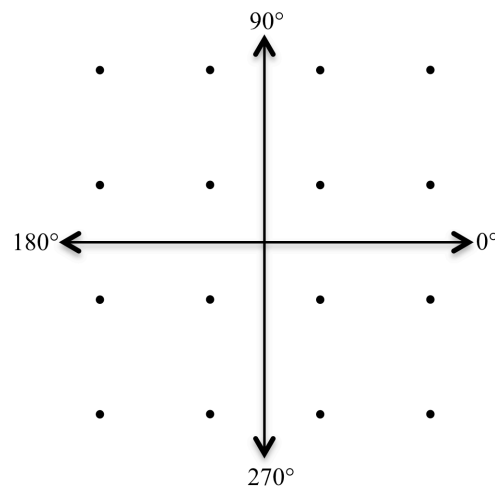

Figure 2.5. Constellation Diagram of 16-QAM

Figure 2.5 shows that 16-QAM uses 16 discrete combinations of phase and magnitude to represent digital data. The 16-QAM scheme is capable of 4 logical bits per symbol.

Introduction to UMTS Device Testing

Transmitter and Receiver Measurements for WCDMA Devices

3GPP Release 7, also known as HSPA+, introduced 16-QAM to the uplink transmissions and 64-QAM to the downlink. 64-QAM utilizes 64 discrete combinations of phase and magnitude, and each symbol represents 6 logical bits. **Figure 2.6** illustrates a constellation diagram for a 64-QAM symbol map.

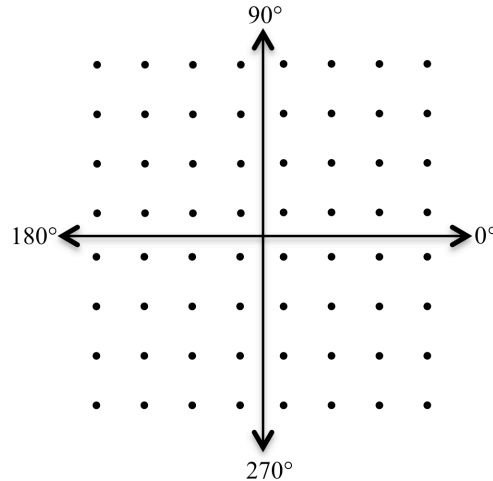

Figure 2.6. Constellation Diagram of 64-QAM.

Table 2.6 illustrates which modulation schemes are supported in various 3GPP releases.

Standard	3GPP Release	Peak DL Modulation	Peak UL Modulation	Notes
UMTS	Release 4	QPSK	QPSK	Commonly referred to as WCDMA
HSDPA	Release 5	16-QAM	QPSK	
HSUPA	Release 6	16-QAM	QPSK	
HSPA+	Release 7	64-QAM	16-QAM	Downlink MIMO
HSPA+	Release 8 and Later	64-QAM	16QAM	Carrier Aggregation in Release 9

Table 2.6. Performance Evolution of 3GPP Standards

Later revisions of the UMTS standard such as 3GPP Release 7 and later also allow for a base station and handset to use multiple concurrent channels, which is known as carrier aggregation. Carrier aggregation, in addition to the inclusion of 2x2 MIMO in Release 7, enable substantially higher data rates than the original UMTS specification.

MIMO and Carrier Aggregation

Starting with 3GPP Release 7, multiple-input-multiple-output (MIMO) and carrier aggregation are key features of HSPA+ that allow for continued increase in transmission data rates. MIMO increases the overall data rate through the transmission of two or more unique data streams through multiple antennas. This process, known as spatial multiplexing, uses the same channelization codes at the same time.

Figure 2.7 illustrates that MIMO schemes enable the transmission of unique data streams on different antennas at the same time. In theory, the transmissions would seem to interfere with one another. However, through of combination multiple receive antennas and knowledge of the channel, the receiver is able to reconstruct each of the unique

Introduction to UMTS Device Testing

Transmitter and Receiver Measurements for WCDMA Devices

transmissions and demodulate them independently. As a result, a 2x2 MIMO system with two transmit and two receive antennas is theoretically capable of a double the bandwidth scheme with only 1 transmit and 1 receive antenna.

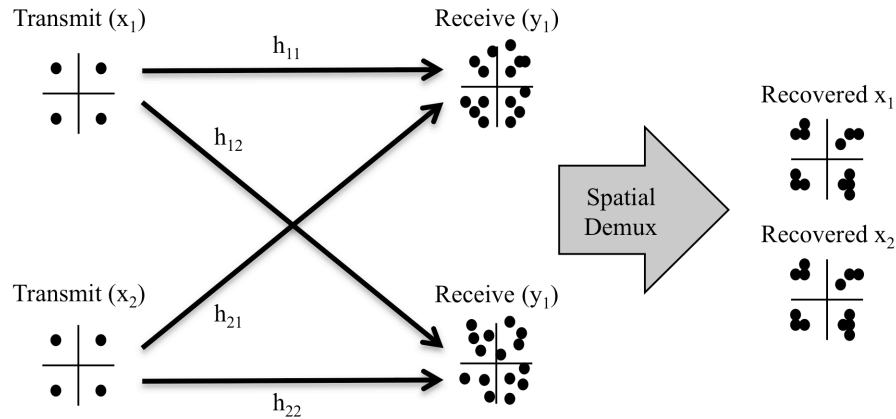

Figure 2.7. Simplified 2x2 MIMO Using Spatial Multiplexing

HSPA+ allows for up to two transmit and two receive antennas for a 2x2 MIMO configuration in the downlink. Note, however, that in 3GPP Release 7, MIMO cannot be used in combination with the 64-QAM modulation scheme. Use of 64-QAM in conjunction with 2x2MIMO is enabled in Release 8 and later.

The combination of MIMO technology with higher order data rates produces a significant increase in maximum data rates. For example, Release 7 allows for data rates of up to 28 Mbps with the combination of both 16-QAM and 2x2 MIMO. In addition, Release 8 allows for data rates of up to 42 Mbps with the combination of both 64-QAM and 2x2 MIMO.

In addition to enhanced MIMO support, Release 8 also adds carrier aggregation to downlink transmissions. In HSPA, the use of two adjacent carriers in downlink transmission is known as dual cell HSDPA (also referred to as Dual Carrier-HSDPA or DC-HSDPA). In DC-HSDPA, each of the two carriers is generated in two adjacent 5 MHz bands, as Figure 2.8 shows.

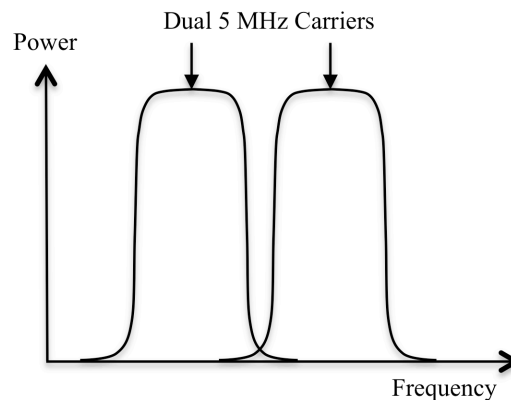

Figure 2.8 Dual Carriers in DC-HSDPA

Introduction to UMTS Device Testing

Transmitter and Receiver Measurements for WCDMA Devices

The benefit of DC-HSDPA results in increased data transmissions rates, but at the direct expense of larger spectrum utilization. 3GPP Release 9 extends the carrier aggregation to uplink transmissions as well. Dual-carrier uplink transmissions are known as DC-HSUPA.

UMTS Frame Structure

WCDMA transmissions are divided into radio frames and slots. **Figure 2.9** shows a 10 ms frame divided into 15 slots (666 us length each). Based on the WCDMA chip rate of 3.84 Mcps, there are 2,560 chips in a time slot and 38,400 chips fit a single radio frame. On the downlink, the time is further subdivided so that the time slots contain fields that contain either user data or control messages. **Figure 2.9** shows the radio frame structure.

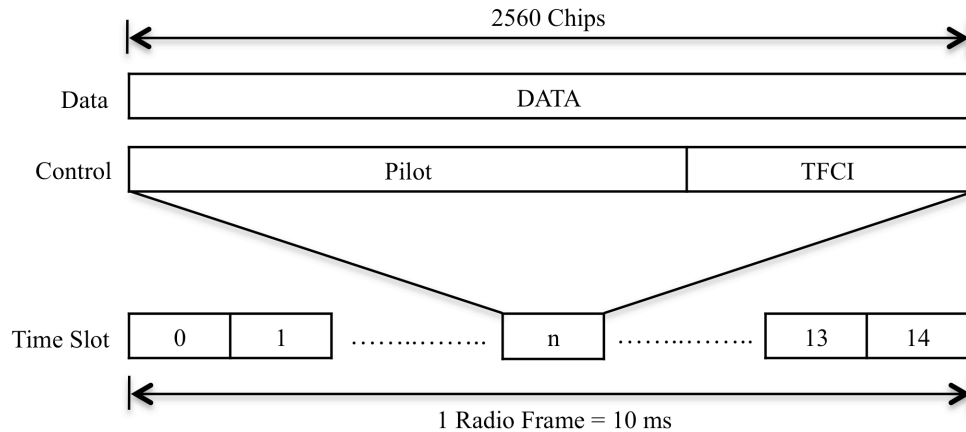

Figure 2.9 Radio Frame and Time Slots

The frame is the fundamental unit of time associated with channel coding and interleaving processes. In uplink transmission, WCDMA uses two different spreading codes to transmit data and control information.

Physical and Logical Channels

Similar to GSM, UMTS defines the notion of logical and physical channels. However, UMTS also adds a new intermediate channel layer – the transport channel. In UMTS, the physical channels carry the payload data and govern the physical characteristics of the signal. By contrast, the logical channels define the way in which the data will be transferred and also serve as a mechanism to categorize the various types of transmissions. Finally, the transport channels define the way in which the data is transferred and allow for the sharing of resources between the uplink and downlink. This document primarily describes the physical channels, and does not explicitly explain the naming conventions of the transport and logical channels. **Figure 2.10** shows a graphical representation of the relationship between each of these layers.

Introduction to UMTS Device Testing

Transmitter and Receiver Measurements for WCDMA Devices

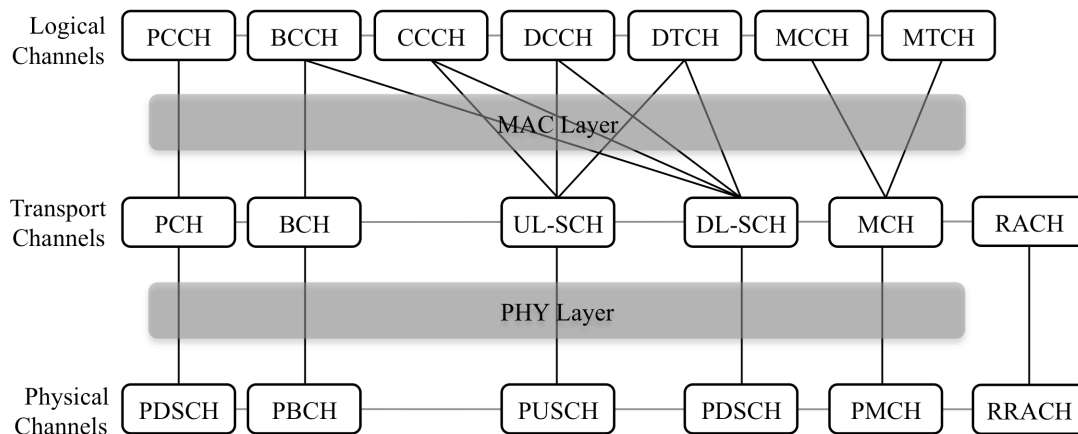

Figure 2.10 Mapping Logical, Transport, and Physical Channels

Figure 2.10 also shows that the nomenclature surrounding the physical, transport, and logical channels of UMTS. Note that although the nomenclature of these channels is complex, it is important to understand the naming conventions of the physical channels in order to configure RF test equipment for either transmitter or receiver testing.

UMTS Physical Channels

Unlike GSM, which separates physical channels by time slot, physical channels in UMTS are primarily defined by their unique scrambling/spreading code used in downlink generation². As a result, the base station is capable of transmitting multiple physical channels simultaneously through the use of unique codes. Physical channels are named according to their function and both uplink and downlink transmissions contain multiple physical channels. In addition, each of these channels can be either dedicated to one particular user or shared between multiple users.

Downlink Physical Channels

In the downlink, there are a wide range physical channels that are either “common” or “dedicated”. The common downlink physical channels are broadcast to all UEs. By contrast, dedicated channels are intended to be received by a single UE and no contention for access should occur. Given the wide range of physical channels, it is useful to understand them in the context of testing UMTS devices. For example, **Table 2.7** illustrates various downlink physical channels that are specifically described by UMTS test model 1.

² ETSI TS 125.211, Section 5

Introduction to UMTS Device Testing

Transmitter and Receiver Measurements for WCDMA Devices

Type	Number of Channels	Fraction of Power (%)	Level setting (dB)	Channelization Code	Timing offset (x256T _{chip})
P-CCPCH+SCH	1	10	-10	1	0
Primary CPICH	1	10	-10	0	0
PICH	1	1.6	-18	16	120
S-CCPCH containing PCH (SF=256)	1	1.6	-18	3	0
DPCH (SF=128)	4*/8*/16/32/64	76.8 in total	See table 6.2	See table 6.2	See table 6.2

Note*: Only applicable to Home BS

Table 2.7 Structure of Downlink Test Model 1³

As **Table 2.7** illustrates, testing UMTS devices requires you to configure test signals that include specific physical channels. Some of the most important downlink physical channels are described below.

- **Primary Common Control Physical Channel (P-CCPCH):** The P-CCPCH carries the broadcast channel, which is a transport channel that carries information about the network and specific cells.
- **Primary Common Pilot Channel (CPICH):** The CPICH carries a timing reference used by the base station to enable demodulation by the UE.
- **Paging Indication Channel (PICH):** The PICH carries a bit mask of reduced paging information to alert the UE of a forthcoming page message. The PICH allows the handset to sleep more of the time thereby conserving battery. The PICH does not carry any higher-layer data.
- **Secondary Control Physical Channel (S-CCPCH):** The S-CCPCH carries several transport channels including forward access channels (FACH) and the paging channel (PCH). The base station uses the FACH to relay various information to the UE and uses the PCH to relay message alerts of incoming calls.
- **Access Indication Channel (AICH):** The AICH indicates the base station's reception of the physical random access channel (PRACH) preamble, which is an uplink physical channel.
- **Dedicated Physical Channel (DPCH):** The DPCH carries both control and data information to the user, and because of this is possibly the most important of the downlink channels. As **Table 2.7** shows, each user is allocated a dedicated DPCH, and test model 1 can be configured to have 4, 8, 16, 32, or 64 channels. The main benefit of separating control and data information in the DPCH is that higher data rates can be achieved by simply adding more dedicated physical data channels and still maintaining one dedicated physical control channel.

Although the UMTS standard originally defined test models 1 through 4 for base station testing, 3GPP Release 5 added test models 5 and 6 to account for new physical channels that were added as part of the HSDPA standard. Physical channels that apply only to HSDPA are given the “HS” qualifier before the physical channel description. **Table 2.8** shows the physical channel naming descriptions.

³ Recreated from Table 6.1 of the ETSI TS 125.151 Specifications

Introduction to UMTS Device Testing

Transmitter and Receiver Measurements for WCDMA Devices

Type	Number of Channels	Fraction of Power (%)	Level Setting (dB)	Channelization Code	Timing offset (x256T _{chip})
P-CCPCH+SCH	1	7.9	-11	1	0
Primary CPICH	1	7.9	-11	0	0
PICH	1	1.3	-19	16	120
S-CCPCH containing PCH (SF=256)	1	1.3	-19	3	0
DPCH (SF=128)	30/4*	27.1 in total	See table 6.6F	See table 6.6F	See table 6.6F
HS-SSCH	2	4 in total	See table 6.6G	See table 6.6G	See table 6.6G
HS-PDSCH (64QAM)	8/4*	50.5 in total	See table 6.6H	See table 6.6H	See table 6.6H
Note*: 8 HS-PDSCH shall be taken together with 30 DPCH, and (for Home BS only) 4 HS-PDSCH shall be taken with 4 DPCH					

Table 2.8. Test Model 6 Active Channels⁴

Table 2.8 shows that test model 6 adds two channels, which are discussed below.

- **High Speed Shared Control Channel (HS-SSCH):** The HS-SSCH provides downlink signaling information that is specific to HSDPA transmissions.
- **High Speed Physical Downlink Shared Channel (HS-PDSCH):** The HS-PDSCH is multiplexed both in time and in code, and is used to carry user data. This channel was introduced in 3GPP Release 5 to carry QPSK or 16-QAM transmissions, and was updated in 3GPP Release 7 to carry 64-QAM transmissions as well.

Uplink Physical Channels

The two most commonly used dedicated uplink physical channels are the dedicated physical data channel (DPDCH) and the dedicated physical control channel (DPCCH).

- **Dedicated Physical Data Channel (DPDCH):** The DPDCH contains voice or message data from the user to the base station.
- **Dedicated Physical Control Channel (DPCCH):** The DPCCH contains physical link control information such as power control bits and the transport format combination indicator.

In addition to dedicated uplink physical channels, uplink transmissions also use shared or common channels. The most common uplink channels are the Physical Random Access Channel (PRACH) and the Physical Common Packet Channel (PCPCH).

⁴ Recreated from Table 6.6E of the ETSI TS 125.151 Specifications

Introduction to UMTS Device Testing

Transmitter and Receiver Measurements for WCDMA Devices

- **Physical Random Access Channel (PRACH):** The PRACH carries the random access request (RACH) from the UE to the base station. The UE uses it to request connection to the network as well as for intermittent services such as low duty cycle packet data.
- **Physical Common Packet Channel (PCPCH):** The PCPCH carries common packet channels and includes information such as access preambles, collision detection preambles, and power control preambles.

UMTS Physical Layer Testing

Certifying a cellular device for consumer use requires a series of transmitter, receiver, and even compliance certification. Understanding the physical layer measurements is a critical part not only of the device manufacturing process, but also the design process. For RF designers who are experienced with GSM systems, WCDMA introduces several new concepts that affect both the complexity and performance of the measurement system. For example, the use of more complex modulation schemes such as 64-QAM introduces unique modulation quality metrics and performance characteristics.

Physical layer measurement focuses on the lowest layer of the air interface and determines conformance with the key parameters essential to the successful transmission of a signal over the air. Transmitter power, modulation quality, and frequency accuracy of the transmitted signal are all key to a UE's performance. On the receiver side, the ability of the UE to successfully decode the received signal at the lowest and highest signal levels defines its operation in the network. The specifications for both UE and base station performance for UMTS operation are defined by the following specifications:

- 3GPP TS 34.121-1: User Equipment (UE) conformance specification; radio transmission and reception (FDD); Part 1: Conformance specification.
- 3GPP TS 34.121-2: User Equipment (UE) conformance specification; radio transmission and reception (FDD); Part 2: Implementation Conformance Statement (ICS).
- 3GPP TS 34.141 – Base station conformance testing specification

The 3GPP WCDMA specifications provide RF conformance criteria to ensure appropriate interoperability between each device.

3. WCDMA Transmitter Measurements

The RF transmitter must be designed in such a way to generate a signal with a given modulation quality while minimizing interference. The receiver likewise must reliably demodulate a WCDMA signal at relatively low power levels, while also rejecting a wide range of interference sources. Performance requirements for these RF aspects aim to ensure that equipment authorized to operate in a WCDMA band meets certain minimum standards.

Similar to GSM transmitter characterization, we can generally divide WCDMA transmitter measurements into the broad categories of power measurements, spectrum measurements, and modulation quality measurements. Although the UMTS specifications define these measurements for both the TDD and FDD mode, the measurements are quite similar between both modes and as a result, this document focuses exclusively on FDD mode. Handset transmitter measurements are defined by Section 5 of the 3GPP TS 34.121 specifications, as illustrated in **Table 3.1**.

Category	Description	3GPP TS 34.121 Section
Power Measurements	Maximum Output Power	5.2
	Output Power Dynamics	5.4
	Transmit ON/OFF Power	5.5
Spectrum Measurements	Occupied Bandwidth	5.8
	Spectrum emissions Mask	5.9
	Adjacent Channel Leakage Ratio	5.10
	Spurious Emissions	5.11
	Transmit Intermodulation	5.12
Modulation Quality	Frequency Error	5.3
	Transmit Modulation	5.13

Table 3.1. Transmitter measurements of WCDMA

Although the full suite of UMTS transmitter measurements are essential to characterize the performance of a handset, only a subset of these measurements are relevant when testing RF components, such as power amplifiers (PAs) or diplexers. In general, only modulation quality (error vector) and spectral measurements (adjacent channel leakage ratio and spectral emissions mask) are the primary figures of merit for RF components. Because these measurements describe the influence of non-ideal components, they are excellent metrics for component performance.

Transmitter Test Setup Configuration

The test and measurement of fully integrated WCDMA handsets typically requires a combination of vector signal generators (VSGs) and vector signal analyzers (VSAs). When characterizing a WCDMA transmitter, a VSA is the preferred instrument, because of its ability not only to make modulation quality measurements, but also to make accurate power and spectrum measurements. When testing these devices, a VSG is also required to source the modulated signal to the device under test. Two example transmitter test setups are illustrated in **Figure 3.1**. In the power amplifier (PA) test configuration, the device under test (DUT) is a PA.

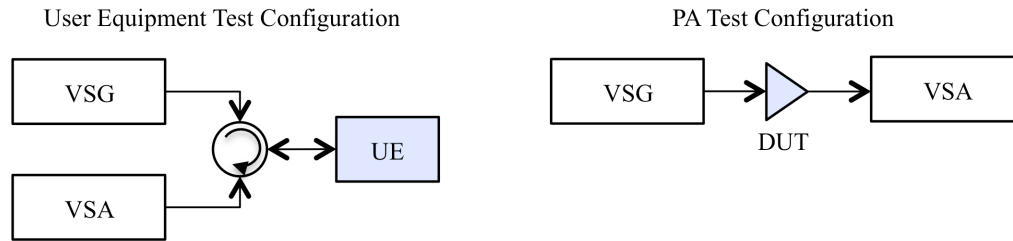

Figure 3.1. Test Setup Configuration for Handset and PA

Figure 3.1 shows that UE test setup requires a circulator to connect both the VSG and VSA to the antenna port.

Tips and Tricks for Improving Measurement Performance

In order to properly perform WCDMA transmitter measurements, one must follow a few key best practices that optimize measurement performance, since it's important to understand the power characteristics of the transmission, and interpret the WCDMA specifications for modern VSAs.

You must configure the input power settings of the VSA to correctly handle the input power of the DUT. Most VSAs are designed to accept an input power as high as +30 dBm peak. As a result, sufficient external attenuation, usually in the range of 20 to 30 dB, must be applied at the input of the VSA to avoid damage to the RF front end. While the VSA itself will have a programmable attenuator at the input, using a large amount of attenuation at the front end has the added advantage of improving the impedance match between DUT and the measurement equipment.⁵

When testing any modulated signal, you must pay careful attention to set the appropriate reference level of the VSA. For example, most VSAs automatically account for the range of modulated signals by applying a “headroom” to the reference level. If, for example, a VSA uses 8 dB of headroom, it would require a signal in excess of 8 dB higher than its programmed reference level to saturate or clip the ADC in it. With some knowledge of the PAPR of the signal being tested, you can optimize the VSA's accuracy by setting the reference level very close to the peak signal power. This configuration will maximize the dynamic range of the measurement.

Power Measurements

WCDMA transmit power measurements are primarily regarded as “in-channel” measurements, and are used to verify that a transmitter is operating at the appropriate power level. In practical use, a WCDMA handset will operate at a range of power levels depending upon the received signal strength at the base station. In general, UEs farther from the base station will transmit at a higher power level, and UEs closer to the base station will transmit at a lower power level. This ensures that the base station receives both signals at similar signal strength, which improves the

⁵ <http://www.ni.com/white-paper/9864/en>

Introduction to UMTS Device Testing

Transmitter and Receiver Measurements for WCDMA Devices

dynamic range of the base station. Thus, not only do the UMTS specifications specify maximum and minimum power requirements for a UE, but also specify power dynamics, which is a metric of transmitted power accuracy.

Although the transmit power is an important measurement of both handsets and components such as PAs, the output power dynamics and transmit ON/OFF power measurements apply specifically to handsets. These two measurements characterize the ability of the UE to control its output power.

For each of the transmit power measurements, a VSA is connected to the UE, and the UE is programmed through a series of power control commands. Each of the following measurements characterize the UE's ability to regulate its own output power, either internally, or in response to commands from the base station.

Maximum Transmit Power Measurement

The maximum transmit power measurement is defined by Section 5.2 of the 3GPP TS 34.121 specifications, and is used in the wireless industry to measure the total transmitted power of a UE within a defined frequency band. This measurement not only ensures transmitters do not interfere with neighboring cells, but also ensures conformance to RF emissions regulations of local government bodies.

The maximum transmit power specification defines that the maximum output power for a UE is the transmission power in a bandwidth greater than $1 + \alpha$ times the chip rate of the radio access mode, where α stands for filter alpha. The transmit power measurement for WCDMA is performed with a 5 MHz integrated bandwidth, and the measurement period for output power should be at least one slot.

Operating Band	Power Class 1		Power Class 2		Power Class 3		Power Class 4	
	Power (dBm)	Tol (dB)	Power (dBm)	Tol (dB)	Power (dBm)	Tol (dB)	Power (dBm)	Tol (dB)
Band I	+33	+1/-3	+27	+1/-3	+24	+1/-3	+21	+2/-2
Band II	-	-	-	-	+24	+1/-3	+21	+2/-2
Band III	-	-	-	-	+24	+1/-3	+21	+2/-2
Band V	-	-	-	-	+24	+1/-3	+21	+2/-2
Band VI	-	-	-	-	+24	+1/-3	+21	+2/-2
Band IX	-	-	-	-	+24	+1/-3	+21	+2/-2

Table 3.2. Maximum Transmit Power Specifications⁶

The UE maximum output power specifications are illustrated in **Table 3.2**. As shown in **Table 3.2**, the nominal maximum output power level is defined as +24 dBm and +21 dBm for power class 3 and power class 4, respectively. The power tolerance is defined as the acceptable power range over which a transmitter can operate at when it's configured to output at its maximum output power. For example, the maximum output power criteria for Band I, power class 3 is such that a device configured to transmit at its maximum output power must produce a power level that is between +21 dBm and +25 dBm.

⁶ 'Recreated From Table 5.2.1 of the GPP TS 34.121 specifications

Visualizing WCDMA Power Characteristics

The power versus time measurement measures the power of a transmitted signal with respect to time. Correlating the measured power with time can help solve power time dependent issues. For example, a decrease in average power with time, or a decrease of PAPR with time, can help explain poor performance with undesirable self-heating effects in the power amplifiers. A VSA can measure power as part of the power versus time measurement trace, shown in **Figure 3.2**.

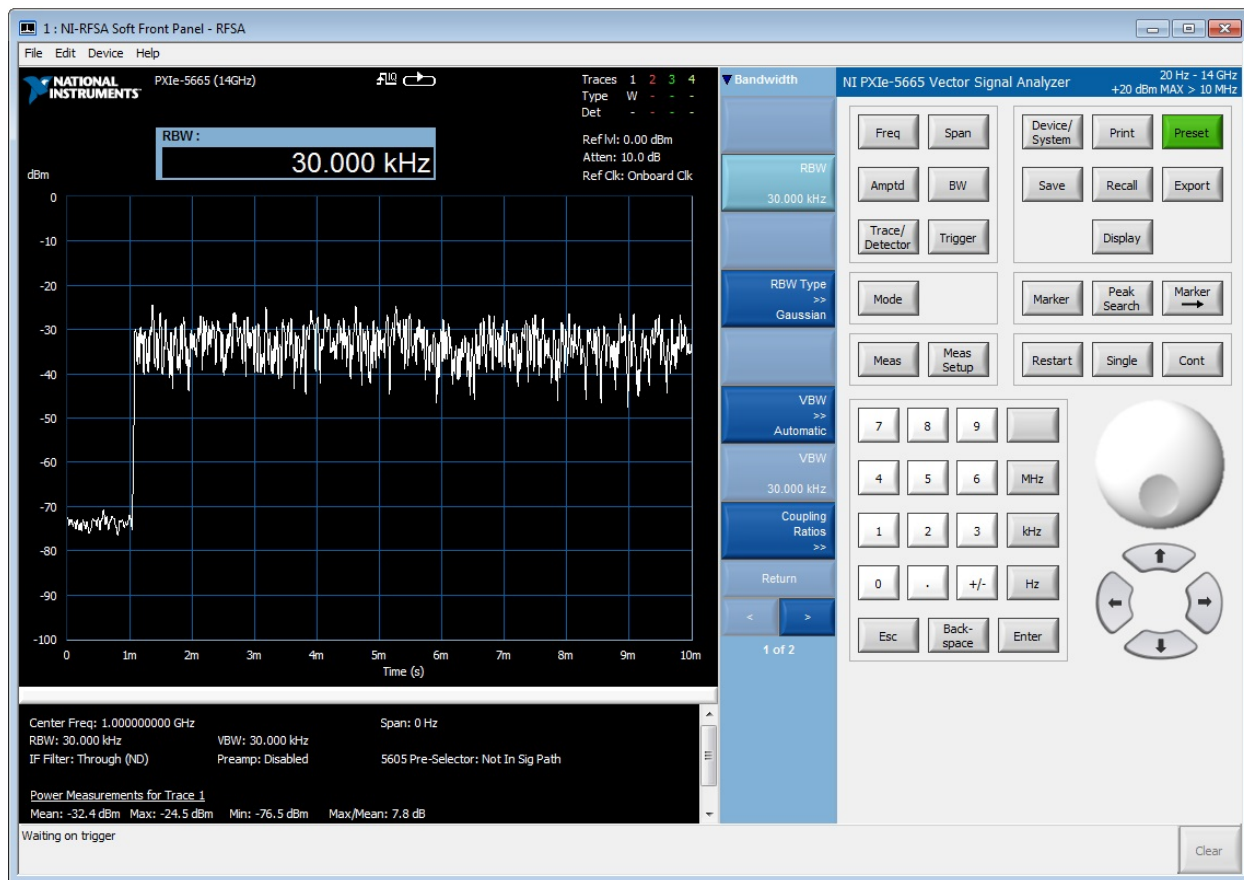

Figure 3.2. Power Versus Time Trace of a WCDMA Signal

Another useful tool when observing the power characteristics of WCDMA signals is the complementary cumulative distribution function (CCDF). The CCDF trace, illustrated in **Figure 3.3**, provides information about the statistical power distribution of the signal. The Y-axis, shows the percentage of time a signal is greater in power than a power level over its average power. For example, the CCDF trace of a UMTS uplink signal in **Figure 3.2** shows a signal that is 4 dB above its average power level 0.01% of the time. The red trace indicates a CCDF trace for a Gaussian distribution of power and provides a reference to the signal in question.

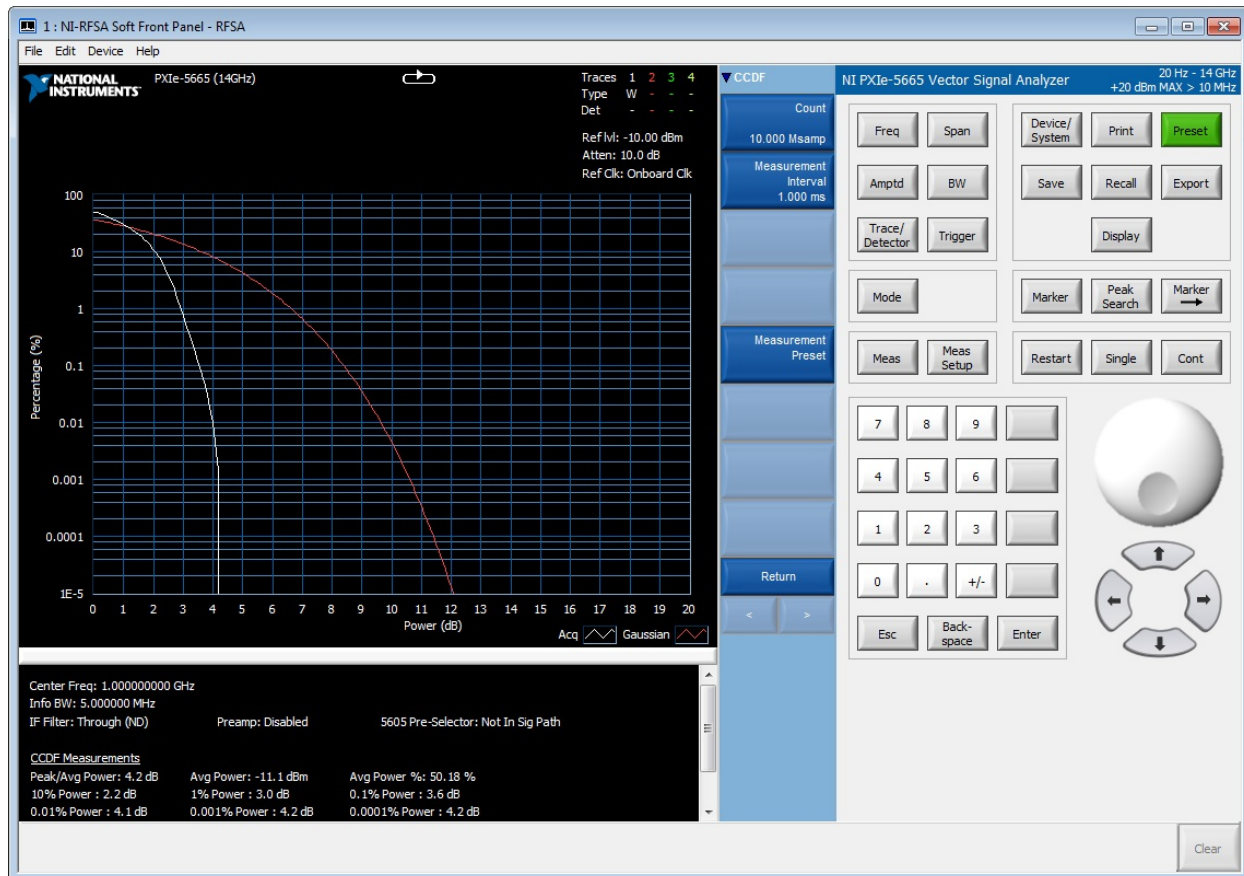

Figure 3.2. CCDF Trace.

You can also use the CCDF trace to measure the PAPR characteristics of the transmission. **Figure 3.2** shows that the PAPR is approximately the point at which the CCDF trace crosses the X-axis. The PAPR of the waveform in **Figure 3.2** is approximately 4.2 dB.

Uplink Output Power Dynamics

The power control and output power dynamics is specified by Section 5.4 of the 3GPP 34.121 specifications. This measurement is used to limit the interference a UE might introduce into other nearby handsets by allowing each handset to transmit at a power level that is appropriate given its distance from a base station. Uplink power control is the ability of the UE transmitter to set its output power in accordance with the measured downlink path loss, which is determined by higher layer signaling and the path loss weighting parameter. This specification applies directly to UE characterization, since the UE is designed to internally moderate its output power. By contrast, the output power dynamics specifications do not directly apply to cellular component characterization. These measurements include open loop power control, inner loop power control, minimum output power, and out of synchronization handling of power control.

Introduction to UMTS Device Testing

Transmitter and Receiver Measurements for WCDMA Devices

Open Loop Power Control

The open loop power control specifications describes the ability of the UE transmitter to set its output power to a specified value without feedback from the base station. This function is used for primary random access channel (PRACH) transmission and is based on the information received from a base station using broadcast control channel (BCCH) and the downlink received signal power level of common pilot channel (CPICH).

The UE uses open loop power control to determine the transmit power of the first PRACH preamble. It allows the UE to regulate its output power even if it loses contact with the base station and ensures that the UE starts with the minimum transmit power level when requesting a radio connection. This is especially important when the UE is closer to the base station, because it prevents a UE from overpowering UE that are farther from the base station. The initial PRACH preamble can be calculated using **Equation 3.1**.

$$\text{Initial PRACH Tx power} = \text{Primary CPICH Tx power} - \text{CPICH}_{RSCP} + \text{Uplink interference} + \text{Constant value}$$

Equation 3.1. Initial PRACH TX Power Calculation⁷

The received signal code power (CPICH_{RSCP}) is the result of the UE reported measurement of the CPICH code channel power and three other parameters that are user definable during the measurement. **Table 3.3** shows the expected output power level for the initial PACH preamble with the primary CPICH power set to simulate low, mid, and high values of path loss.

⁷ 3GPP TS 25.331 Specifications, Section 8.5.7.

		RX Upper dynamic end	RX middle	RS Sensitivity level
I_{or}		-25.0 dBm/3.84 MHz	-65.7 dBm/3.84 MHz	$\langle REFI_{or} \rangle_{dBm}/3.84\text{ MHz}$
CPICH_RSCP		-28.9 dBm	-69.6 dBm	$\langle REFI_{or} \rangle + CPICH_E_c/I_{or}$
Primary CPICH DL TX power		+19 dBm	+28 dBm	+19 dBm
Simulated path loss = Primary CPICH DL TX power – CPICH_RSCP		+47.9 dB	+97.6 dB	Band I, IV, VI: +128.9 dB Band II, V, VII: +126.9 dB Band III, VIII: +125.9 dB Band IX: +127.9 dB
UL interference	Band I, IV, VI	-75 dBm	-101 dBm	-110 dBm
	Band II, V, VII			-108 dBm
	Band III, VIII			-107 dBm
	Band IX			-109 dBm
Constant Value		-10 dB	-10 dB	-10 dB
Expected nominal UE TX power		-37.1 dBm	-13.4 dBm	+8.9 dBm

Table 3.3. Test Parameters for Open Loop Power Control⁸

Inner Loop Power Control Measurement

The inner loop power control measurement describes the ability of the UE transmitter to adjust its output power in accordance with one or more transmit power control (TPC) commands it receives on the downlink. The inner power loop control specifications are more stringent than open loop power control, because the feedback from the base station should theoretically improve a UE's ability to control its output power.

The UE transmitter is capable of changing its output power in step sizes of 1 dB, 2 dB and 3 dB in response to one or more TPC commands received by the base station. The step size required for transmit power control are sent on the BCCH. The transmitter output power step for each inner loop power control step size is specified to be within the range that is shown in **Table 3.4**.

⁸ Recreated From Table 5.4.1.3 of the 3GPP TS 25.331 Specifications

Introduction to UMTS Device Testing

Transmitter and Receiver Measurements for WCDMA Devices

TPC Command	Transmitter Power Control Range (dB)					
	1 dB Step Size		2 dB Step Size		3 dB Step Size	
	Lower	Upper	Lower	Upper	Lower	Upper
+1	+0.5	+1.5	+1	+3	+1.5	+4.5
0	-0.5	+0.5	-0.5	+0.5	-0.5	+0.5
-1	-0.5	-1.5	-1	-3	-1.5	-4.5

Table 3.4 Transmitter Power Control Range⁹

As a result of multiple TPC commands, the transmitter adjusts its output power within a wider power range. The aggregate output power change due to inner loop power control should be within the range shown in **Table 3.5**.

TPC_cmd group	Transmitter power control range after 10 equal TPC_cmd group (all units are in dB)				Transmitter power control range after 7 equal TPC_cmd groups (all units are in dB)	
	1 dB step size		2 dB step size		3 dB step size	
	Lower	Upper	Lower	Upper	Lower	Upper
+1	+8	+12	+16	+24	+16	+26
0	-1	+1	-1	+1	-1	+1
-1	-8	-12	-16	-24	-16	-26
0,0,0,0,+1	+6	+14	N/A	N/A	N/A	N/A
0,0,0,0,-1	-6	-14	N/A	N/A	N/A	N/A

Table 3.5. Transmitter Aggregate Power Control Tolerance¹⁰

The procedure for testing inner loop power control is strictly defined by Section 5.4 of the 3GPP TS 34.121 specifications. When performing this measurement, you must send the UMTS handset a range of TPC commands so that its output power will follow the profile shown in **Figure 3.3**.

⁹ Recreated From Table 5.4.2.1 of the 3GPP TS 25.331 Specifications

¹⁰ Recreated From Table 5.4.2.2 of the 3GPP TS 25.331 Specifications

Introduction to UMTS Device Testing

Transmitter and Receiver Measurements for WCDMA Devices

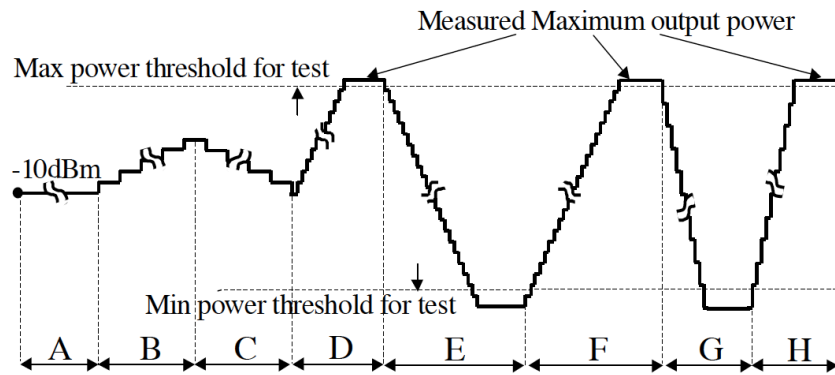

Figure 3.3. Output Power Profile When Testing Inner Loop Power Control¹¹

Figure 3.3 shows the transmitter outputs a UMTS signal starting in state “A” and ending in state “H.” The TPC commands that cause the handset to produce the output power profile shown in Figure 3.3 are provided in Table 3.6.

Test Segment	Step Size	Start Power (nominal)	TPC Command Sequence
A	1 dB	- 10 dBm	Send TPC commands with value ‘0’, the number of TPC commands depends on the number of slots.
B	1 dB	- 10 dBm	Send up to 50 TPC commands with value ‘0,0,0,+1’
C	1 dB	0 dBm	Send up to 50 TPC commands with value ‘0,0,0,-1’
D	1 dB		
E	1 dB	UE Maximum Output Power	Send up to 300 TPC commands with value ‘0,0,0,+1’
F	1 dB	UE Minimum Output Power	Send up to 300 TPC commands with value ‘0,0,0,-1’
G	2 dB	UE Maximum Output Power	Send up to 150 TPC commands with value ‘0,0,0,+1’
H	2 dB	UE Minimum Output Power	Send up to 150 TPC commands with value ‘0,0,0,-1’

Table 3.6. Test Step Requirements Summary

The test segment is described below in the Table 3.6. Algorithm 1 means that each TPC symbol is evaluated in every consecutive transmit time slot while Algorithm 2 means that five consecutive TPC symbols are always grouped together and the UE processes TPC commands on a 5 slot cycle.

¹¹ Used With Permission from Figure 5.4.2.4 of the 3GPP TS 34.121 Specifications

Minimum Output Power

Although the inner loop and open loop power control specifications deal with a transmitters ability to control its output power, the minimum output power specifications define a UE's ability to transmit at a specific output power. When the transmitter is configured to be the minimum power control value, the UE must transmit at the specified limit (-50 dBm) or below this value. For UE power class 3, the specified power range is -50 dBm to +24 dBm. An excess minimum output power increases the interference to other channels, and decreases the system capacity.

When measuring minimum output power, the VSA is configured to perform a power-in-band measurement over a bandwidth of 5 MHz. The UE minimum transmit power is -50 dBm. An excess minimum output power increases the interference to other channels, and decreases the system capacity.

Out-of-synchronization Handling of Output Power

The final output power dynamics requirement for UMTS transmitters is the out-of-synchronization handling of output power specification defined by Section 5.4.4 of the 3GPP TS 34.121 specifications. This requirement describes the ability of a UE to monitor the quality of the base station's DPCCH and appropriately turn its transmitter off or on.

In general operations, a UE that losses connection with the serving base station will continue to search for synchronization by monitoring the DPCCH channel. The UE monitors the quality of the DPCCH channel by measuring the ratio of the transmitted energy per pseudorandom (PN) chip of DPCCH to the total transmit power spectrum density. The energy per PN chip can be thought of as the code domain power of the DPCCH channel, and the transmit power spectrum density is denoted by the abbreviation I_{or} . Thus, the resulting ratio of the DPCCH power to the overall transmit power is described as " $DPDCH_Ec/I_{or}$." The UMTS standard specifically defines " I_{or} " as the power (in dBm) over an integrated bandwidth of $3.84 \text{ MHz} * (1 + \alpha)$, where $\alpha = 0.22$. Thus, the integrated bandwidth is $3.84 \text{ MHz} * 1.22$, or 4.68 MHz.

The UMTS specifications define both minimum (Q_{out}) and maximum (Q_{in}) thresholds for the $DPDCH_Ec/I_{or}$ ratio as well as the maximum time for a transmitter to turn off or on. **Figure 3.4** shows that when the UE estimates the DPCCH quality has been lower than the threshold Q_{out} for a period longer than 160 milliseconds, the UE should shut its transmitter off within 40 milliseconds. By contrast, when the DPCCH quality has been higher than the threshold Q_{in} for a period longer than 160 milliseconds, the UE should also shut its transmitter off within 40 milliseconds.

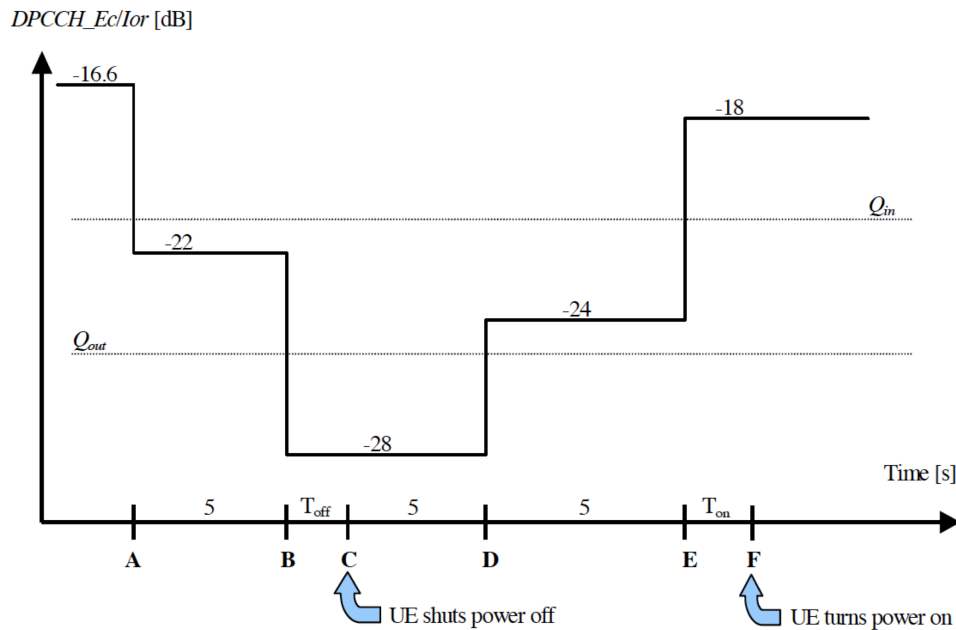

Figure 3.5. Transmitter Profile for Out of Synchronization of Handling of Output Profile¹²

Figure 3.5 also illustrates the test procedure for out-of-synchronization handling of output power by defining states ‘A’ through ‘F’ of the transmit power. These states are specifically defined in Table 3.7 by a power ratio.

Clause from Figure	DPCCH_Ec/I _{or} (dB)
Before A	-16.6
A to B	-22.0
B to D	-28.0
D to E	-24.0
After E	-18.0

Table 3.7 Minimum Requirements for DPCCH_Ec/I_{or} Ratio¹³

Table 3.7 shows that the start condition is a DPCCH_Ec/I_{or} ratio of -16.6 dB. At time period “A” this ratio changes to -22 dB for a duration of 5 seconds. After five seconds, the ratio drops to -28.0 dB, which is below the Q_{in} threshold. At time “C” the DPCCH_Ec/I_{or} has been lower than Q_{in} for greater than 160 milliseconds and the transmitter begins to turn off. The remainder of this test procedure continues on from states “D” to “F” in the manner described by Figure 3.5 and Table 3.7.

¹² Used With Permission from Figure 5.4.4.1 of the 3GPP TS 34.121 Specifications

¹³ Recreated From Table 5.4.4.1 of the 3GPP TS 25.331 Specifications

Introduction to UMTS Device Testing

Transmitter and Receiver Measurements for WCDMA Devices

Transmit ON/OFF Power

The transmit ON/OFF power measurement is defined by 3GPP 34.121 Section 5.5, and it plays an important role in WCDMA for evaluating the ON and OFF switching behaviour of WCDMA transmitters. The power ON/OFF switching behaviours are generally caused by the commands relating to power control sent from the base station, particularly for a handset. This measurement looks at the signal in time, verifying that the PA is turning on and off at the correct time without producing any extraneous signals. Unlike the transmit power measurement, which relies on output at a continuous output power, the transmit ON/OFF measurement deals with bursted power at the output of the UE. As a result, you must configure a VSA for a power triggered acquisition.

Transmit OFF power

Although the UE would ideally not emit power when not sending data, this is not entirely the case in practice. In fact, the UE transmits residual output power even when is not actively sending data. The transmit power OFF power measurement is used to characterize output emissions when the radio is not sending data.

Unlike the minimum output power measurement, which ensures that a UE can produce an WCDMA uplink signal at a relatively lower output power, the transmit OFF power measurement prescribes the maximum power a UE can emit during periods when the UE is not allowed to transmit or during periods when the UE is not transmitting. Testing of transmit OFF power ensures that the UE transmit power is less than -56 dBm when the transmitter is OFF. An excess transmit OFF power increases the interference to other channels, and decreases the system capacity.

Transmit ON/OFF Time mask

The time mask for transmit ON/OFF specifications defines the requirements for the power ramp time allowed by the UE as it switches between transmit OFF power and transmit ON power. More specifically, this measurement defines both the power-on time at the beginning of a transmission and the power-off time at the end of a transmission. This test ensures that the transition from one state to another is adequately controlled.

Although Section 5.5.2 of the 3GPP 3GPP TS 34.121 specifications illustrates transmit ON/OFF time mask requirements for a variety of physical channels, the performance required is similar. Generally, UMTS transmitters must transition from the OFF state to the ON state in 25 μ S. For example, consider the ON/OFF time mask for a PRACH transmission in **Figure 3.6**, which illustrates that the power level of a UE transmission must fall below the minimum threshold at the end of the burst.

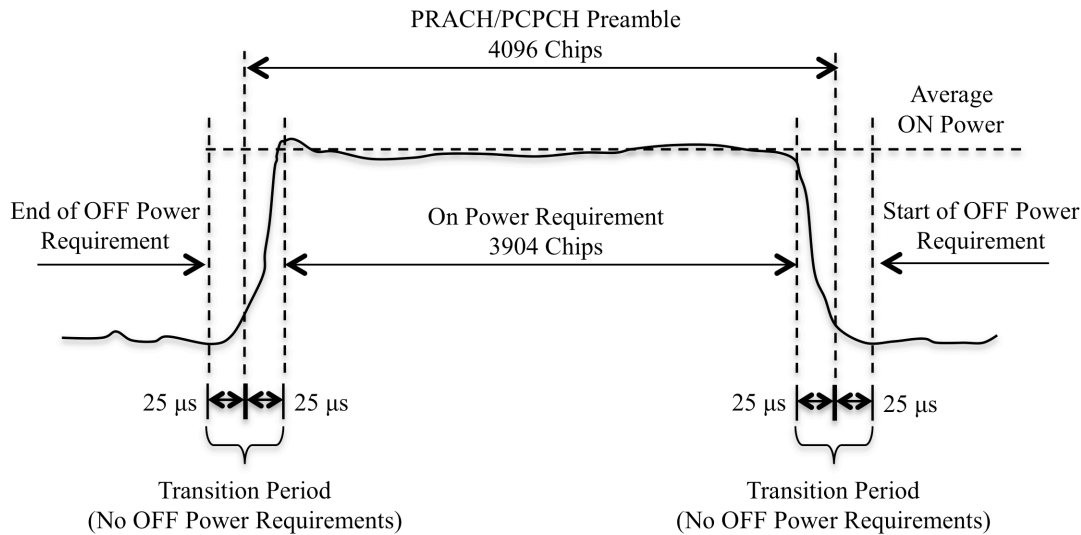

Figure 3.6. Transmit ON/OFF Template for PRACH Preamble¹⁴

Figure 3.6 shows that the transition from off to on and from on to off must occur within 25 μ S. In addition, the active portion of a PRACH preamble is 3,904 chips. The OFF power requirements is less than -56 dBm. Although the transmitter must meet these requirements for all transmit output powers, the most difficult case is typically the UE's maximum output power. As a result, this measurement is typically performed with the transmitter operating at its maximum output power.

Spectrum Measurements

In addition to characterizing the modulation quality and power characteristics of WCDMA transmitters, spectrum measurements of WCDMA transmitters are also essential. This family of measurements is generally required to ensure interoperability of one wireless handset with other handsets. More specifically, measurements such as occupied bandwidth and adjacent channel leakage ratio characterize the leakage of signal power into adjacent bands, which could potentially interfere with devices operating in those bands. This section discusses the following spectrum measurements:

- Occupied bandwidth (OBW)
- Spectral emissions mask (SEM)
- Adjacent channel leakage ratio (ACLR)
- Spurious emissions

¹⁴ Recreated from Figure 5.4.1 of the 3GPP TS 34.121 Specifications

- Transmit intermodulation

Occupied Bandwidth Measurement

Occupied bandwidth (OBW) is defined by Section 5.8 of the 3GPP 34.121 specifications. For WCDMA, the OBW is a metric of the bandwidth containing 99% of the total integrated power of the transmitted spectrum and should be less than 5 MHz based on a chip rate of 3.84 Mcps.

The OBW can be measured easily by performing spectrum measurements with a VSA. Based on the definition given in Section 5.8 of the 3GPP 34.121, the OBW is measured as shown in **Figure 3.7**.

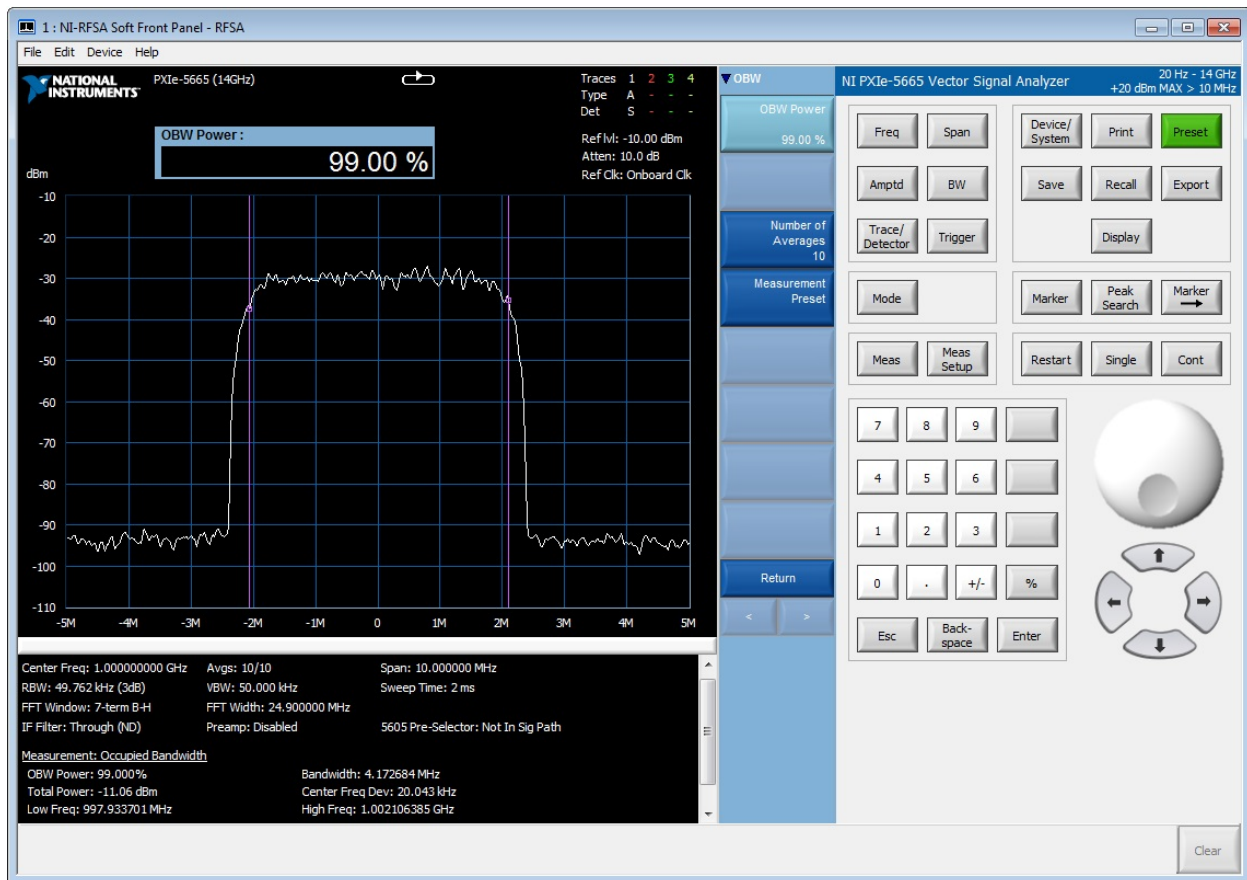

Figure 3.7. Occupied bandwidth

For a specified percentage B, the upper and lower limits of the frequency band are the frequencies within which the total power is found. The OBW is the bandwidth that contains 99% of the total power of the signal. **Figure 3.7** shows a calculated occupied bandwidth of 4.1753 MHz. The occupied bandwidth measurement is fundamentally a frequency domain measurement and requires you to configure the VSA to be at least two times the bandwidth of the transmitted signal.

Introduction to UMTS Device Testing

Transmitter and Receiver Measurements for WCDMA Devices

Spectrum emission mask

The WCDMA spectrum emissions mask (SEM) measurement is specified in Section 5.9 of the 3GPP 34.121 specifications. Spectrum emissions mask is one of two spectral emissions measurements defined by the UMTS standard. Generally speaking, the SEM measurement has easier acceptance criteria, and is designed to capture unwanted spurious products that the UE might emit. By contrast, the adjacent channel leakage ratio (ACLR) measurement, described in the following section, is generally considered to have more difficult acceptance criteria, and is predominantly used as a metric of the non-linearity of the transmitter's PA.

The SEM is a mask defined for out-of-channel emissions relative to the in-channel power and this measurement ensures that the signal in adjacent channels falls off in a manner that minimizes interference. The SEM of the UE applies to frequencies between 2.5 MHz and 12.5 MHz away from the UE center frequency. You can measure the emissions in the frequency range that are closest to the carrier (2.5 MHz to 3.5 MHz) by using a Gaussian filter with a bandwidth of 30 kHz. By contrast, emissions measured in a frequency offset ranging from 3.5 MHz to 12.5 MHz require a measurement bandwidth of 1 MHz.

You can visually observe the effect of test limits on the measurement bandwidth in Figure 3.8. As we observe in Figure 3.8, the emissions limit seems to jump at ± 3.5 MHz, where the integrated measurement bandwidth increase from 30 kHz to 1 MHz.

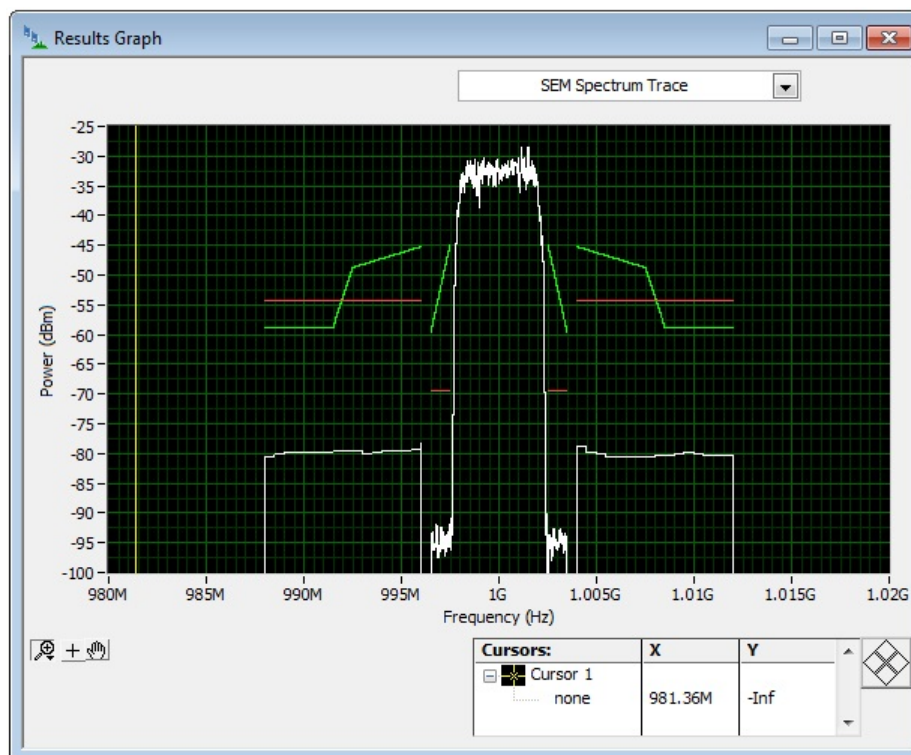

Figure 3.8. Typical Spectrum With SEM Limits

Introduction to UMTS Device Testing

Transmitter and Receiver Measurements for WCDMA Devices

The power of any UE emission should not exceed the levels specified in **Table 3.8**. The absolute requirement is based on a -50 dBm/3.84 MHz minimum power threshold for the UE. This limit is expressed for the narrower measurement bandwidths as -55.8 dBm/1 MHz and -71.1 dBm/30 kHz.

Δf (MHz) *	Minimum Requirement†		Measurement bandwidth
	Relative requirement	Absolute Requirement	
2.5 - 3.5	$\left\{ -35 - 15 \cdot \left(\frac{\Delta f}{\text{MHz}} - 2.5 \right) \right\} \text{dBc}$	-71.1 dBm	30 kHz ‡
3.5 - 7.5	$\left\{ -35 - 1 \cdot \left(\frac{\Delta f}{\text{MHz}} - 3.5 \right) \right\} \text{dBc}$	-55.8 dBm	1 MHz **
7.5 - 8.5	$\left\{ -39 - 10 \cdot \left(\frac{\Delta f}{\text{MHz}} - 7.5 \right) \right\} \text{dBc}$	-55.8 dBm	1 MHz **
8.5 - 12.5 MHz	-49 dBc	-55.8 dBm	1 MHz **
*:	Δf is the separation between the carrier frequency and the centre of the measurement bandwidth.		
†:	The minimum requirement is calculated from the relative requirement or the absolute requirement, whichever is the higher power.		
‡:	The first and last measurement position with a 30 kHz filter is at Δf equals to 2.515 MHz and 3.485 MHz.		
**:	The first and last measurement position with a 1 MHz filter is at Δf equals to 4 MHz and 12 MHz.		

Table 3.8. Spectrum Emission Mask Requirements¹⁵

The power of any UE emission shall not exceed the levels specified in **Table 3.8**. **Table 3.8** shows that emissions are measured in a 30 kHz bandwidth within a 2.5 MHz to 3.5 MHz offset from the carrier. By contrast, offsets greater than 3.5 MHz require a 1 MHz measurement bandwidth.

Adjacent Channel Leakage Ratio (ACLR)

A second and perhaps one of the most important out-of-band measurements in WCDMA is adjacent channel leakage ratio (ACLR), which is primarily used to quantify the level of adjacent channel interference. Adjacent channel interference is the result of a transmission at the desired frequency channel producing unwanted energy in other channels

Although the SEM measures the spurious output performance of the transmitter, the ACLR measures the integrated power in an adjacent band. Even though both measurements characterize emissions into adjacent bands at some level, the ACLR measurement generally has more stringent requirements. This type of interference is common and primarily created by spectral regrowth out of the assigned frequency channel and into the surrounding upper and

¹⁵ Recreated From Table 5.9.1 of the 3GPP TS 34.121 Specifications

Introduction to UMTS Device Testing

Transmitter and Receiver Measurements for WCDMA Devices

lower channels. This energy splatter, often referred to as intermodulation distortion or spectral re-growth, is created in the high-power amplifiers of the radio transmitter due to nonlinear effects in the power electronics.

Digitally modulated WCDMA signals are carefully designed to occupy a specific channel bandwidth of 5MHz. Because the design of pulse shaping filters, like the root-raised cosine filter, constrains the bandwidth of the modulated signal, the primary source of adjacent channel leakage is due to the non-linearity of the final output PA. Because of this, this measurement is a critical defining characteristic of the PA itself. **Figure 3.9** illustrates that the intermodulation products introduced in a non-linear system create spectral re-growth into adjacent bands.

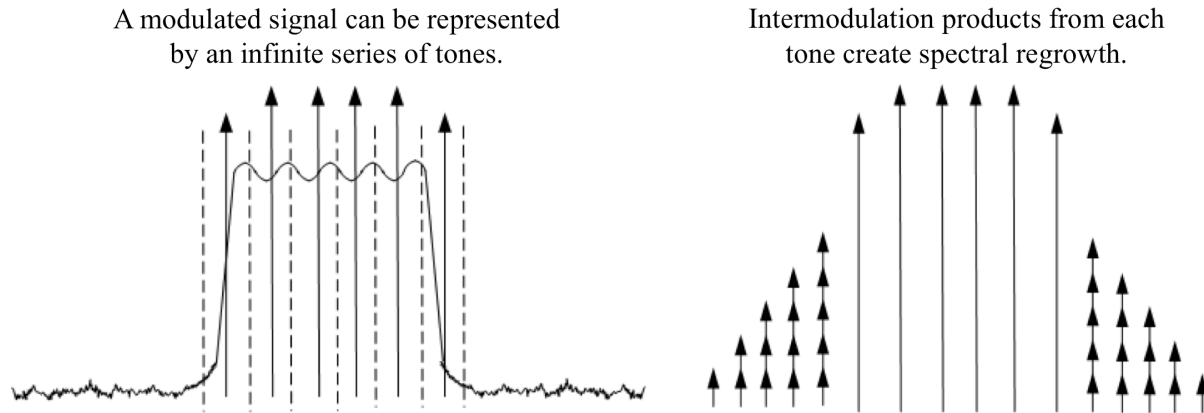

Figure 3.9. Effect of Intermodulation Distortion on ACLR

The 3GPP specifications define two ACLR performance levels of -33 dB for a 5MHz offset and -43 dB for a 10 MHz offset. If the adjacent channel root raised cosine (RRC) filtered mean power is greater than -50 dBm then the ACLR should be higher than the value specified in **Table 3.9**.

Power Class	UE channel	ACLR limit
3	+5 MHz or -5 MHz	-33 dB
3	+10 MHz or -10 MHz	-43 dB
4	+5 MHz or -5 MHz	-33 dB
4	+10 MHz or -10 MHz	-43 dB

Table 3.9. UMTS Transmitter ACLR Specification Limits¹⁶

¹⁶ Recreated From Table 5.10.1 of the 3GPP TS 34.121 Specifications

Introduction to UMTS Device Testing

Transmitter and Receiver Measurements for WCDMA Devices

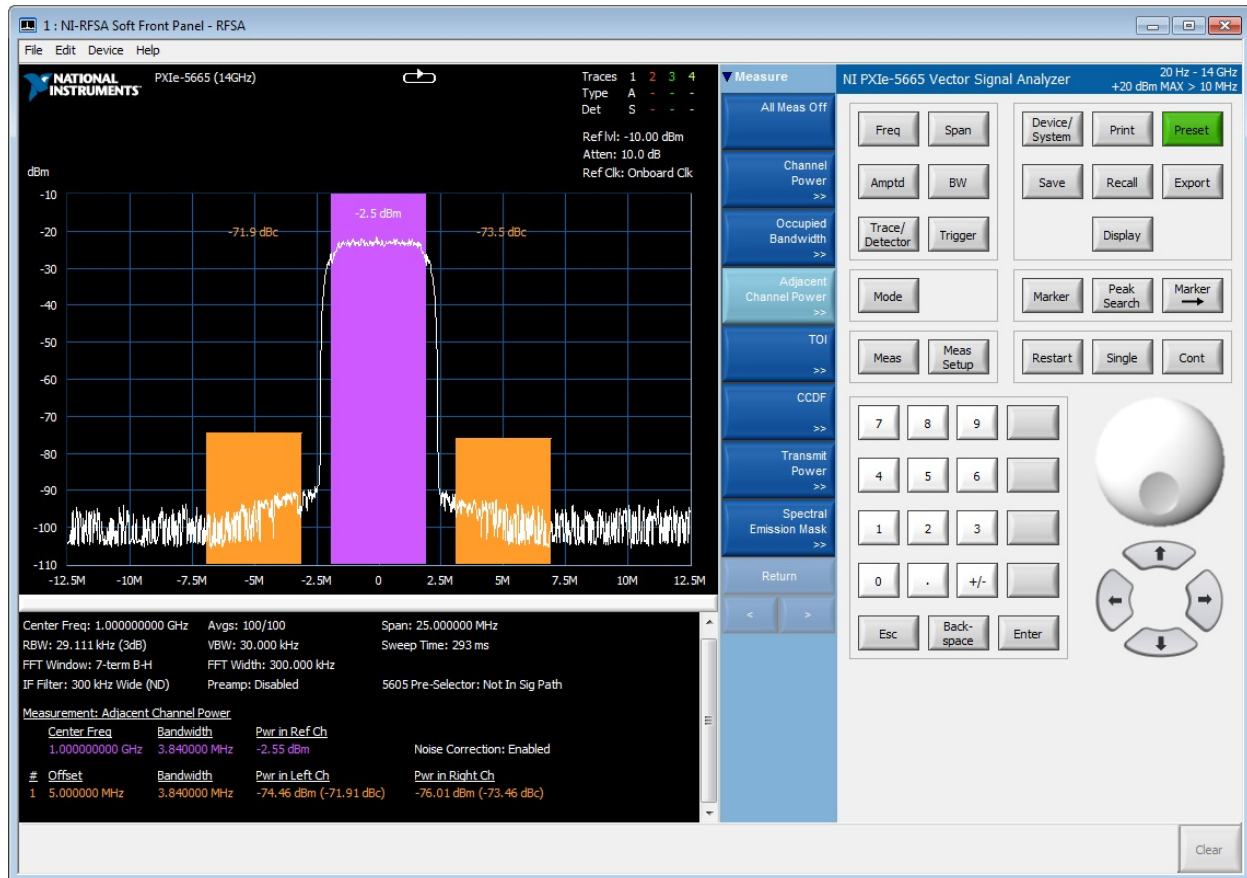

Figure 3.10 Typical Display of ACLR Measurement Result

Figure 3.10 shows an ACLR measurement for a WCDMA uplink signal. This figure displays the main channel power and the power of the adjacent channel and first alternate channel on either side. Note that the channels appearing at ± 5 MHz are referred to as the adjacent channels, and the channels at ± 10 MHz are considered the alternate channels. The waveforms under the red bars indicate the measured power in the adjacent and alternate channels. The green lines reflect the ACLR limits.

Introduction to UMTS Device Testing

Transmitter and Receiver Measurements for WCDMA Devices

When measuring ACLR, the signal analyzer applies RRC filtering both the power in the main frequency channel and the power in the adjacent channels. The measurement is performed with a VSA with an appropriate RRC filter as specified in Sec. 5.10 of the 3GPP 34.121 specifications.

Because the ACLR measurement is often one of the most demanding measurements of a UMTS transmitter, careful attention must be placed on the reference level of the VSA. Generally, the ideal reference level is set to just below the saturation or clipping level of the VSA. This allows for the maximum dynamic range of the VSA, while preventing distortion resulting from ADC clipping.

Spurious Emissions

Spurious emissions testing, as prescribed by Section 5.11 of the 3GPP 34.121 specifications, are emissions that are caused by unwanted transmitter effects such as harmonics emission, parasitic emission, intermodulation products and frequency conversation products, but exclude out of band emissions. Spurious emissions occur well outside the bandwidth necessary for transmission and may arise from a large variety of non-ideal effects including harmonic emissions and intermodulation products. The magnitude of the spurious emission may or may not vary with the transmitter's power. These requirements are only applicable for frequencies greater than 12.5 MHz away from the UE center carrier frequency and the limits are defined in **Table 3.10**.

Frequency Bandwidth	Measurement Bandwidth	Minimum requirement
$9 \text{ kHz} \leq f < 150 \text{ kHz}$	1 kHz	-36 dBm
$150 \text{ kHz} \leq f < 30 \text{ MHz}$	10 kHz	-36 dBm
$30 \text{ MHz} \leq f < 1000 \text{ MHz}$	100 kHz	-36 dBm
$1 \text{ GHz} \leq f < 12.75 \text{ GHz}$	1 MHz	-30 dBm

Table 3.10 *General Transmitter Spurious Emissions Limits*¹⁷

As an exception, up to five measurements with a level up to the applicable minimum requirements defined in **Table 3.10** are permitted in each of the following bands: 925 MHz to 960 MHz and 1805 MHz to 1880 MHz for each UARFCN used in the measurement¹⁸. Excess spurious emissions increase the interference to other systems.

Transmit Intermodulation

The transmit intermodulation is defined by Section 5.12 of the 3GPP 34.12 specifications and is a metric of the linearity of the UMTS transmitter's front end. This measurement measures the capability of the transmitter to prevent the generation of intermodulation products in the presence of an interference signal.

Although transmissions from wireless devices would ideally not affect a UE's transmission, this is not always the case in practice. In fact, the transmission from one UE can enter the transmitter of another UE. In addition, if the UE

¹⁷ Recreated from Table 5.11.1a from 3GPP TS 134.121 Specifications

¹⁸ 3GPP TS 45.005 Specifications

Introduction to UMTS Device Testing

Transmitter and Receiver Measurements for WCDMA Devices

transmitter is not perfectly linear, the introduction of a signal at a frequency that is offset from the transmitter frequency will produce intermodulation products at the output of the transmitter.

The transmit intermodulation measurement mimics the introduction of other wireless signals into the transmitter by introducing a CW tone to the receiver. **Figure 3.11** illustrates the measurement configuration, which includes a CW signal generator to produce an interference signal that is offset from the carrier frequency of the transmitter by either 5 MHz or 10 MHz.

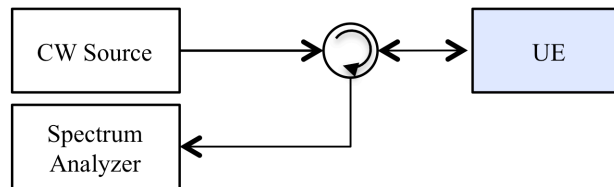

Figure 3.11. Block diagram of Intermodulation Test Setup

Based on the configuration in **Figure 3.11**, the output of the UMTS transmitter will contain both the UMTS signal as well as intermodulation products. **Figure 3.12** shows intermodulation products that are spaced at an offset frequency that is equal to the frequency separation between the UE's transmitted signal and the interfering tone.

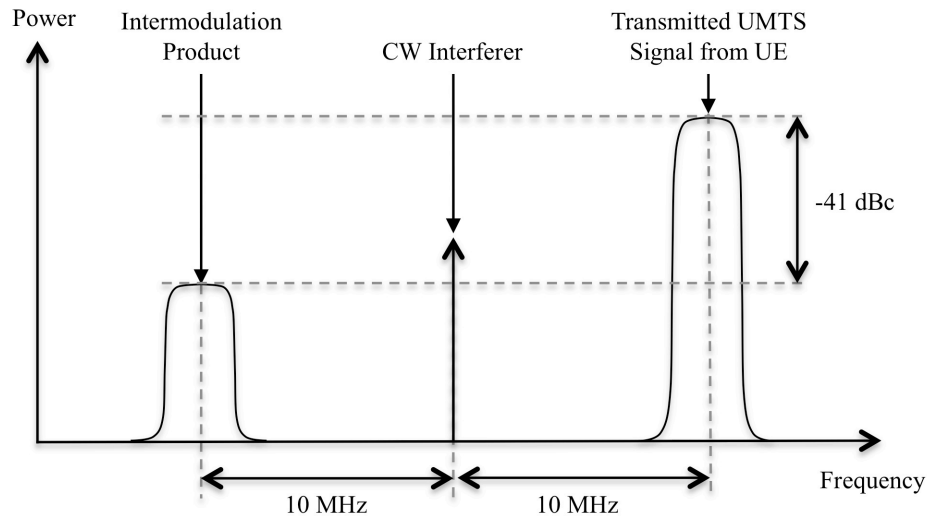

Figure 3.12. Spectral Content at Output of UMTS Transmitter with 10 MHz Offset Interferer

The UE transmit intermodulation attenuation is strictly defined as a ratio of the RRC filtered mean power of the wanted signal to the RRC filtered mean power of the intermodulation product. Observe in **Table 3.11**, that the intermodulation requirements are dependent upon the offset of the CW interferer from the transmitting carrier.

CW Signal Frequency Offset from Transmitting Carrier	5MHz	10MHz
Interference CW Signal Level	-40 dBc	
Intermodulation Product	-31 dBc	-41 dBc

Table 3.11. Transmit Intermodulation Specifications¹⁹

Note that **Table 3.11** does not specify the power of the transmitting carrier, because the specification requirements must be met for all output power levels of the transmitter. Because the intermodulation characteristics are worse at higher power levels, you can generally assume that if a UE passes the requirements at its highest output power, it will meet these requirements for all output power levels.

Transmit Modulation Quality

Transmitter modulation quality measurements are specified by Section 5.13 of the 3GPP 34.121 specification. Unlike GSM, which uses Gaussian minimum shift keying (GMSK), and therefore has a constant power envelope, WCDMA uses more complex modulations schemes with more power variation. As a result, characterizing the errors in amplitude is comparatively more important in WCDMA, since the modulation impairments are more common. In this section, the following modulation quality measurements will be discussed:

- Frequency Error
- Error Vector Magnitude

In a cellular communications system, the quality of the transmitted radio signal must be high enough to ensure that it can be demodulated by the receiver. The quality of the transmitted radio signal must fulfil certain requirements. Transmit modulation defines the modulation quality for expected in-channel RF transmissions from the handset.

Frequency Error

Frequency error measurements are specified by Section 5.3 of the 3GPP TS 34.121 specification document. As with any communications system, the transmitter must be operating on the correct frequency. The frequency error is defined as the difference between the RF modulated carrier frequency transmitted from the UE and the assigned frequency. The UE transmitter tracks to the RF carrier frequency received from the base station. These signals will have an apparent error due to base station frequency error and Doppler shift in the actual environment. The frequency error is usually given in parts per million (ppm), and is expressed as a ratio of the error and carrier frequency. Frequency accuracy will affect the system performance in many areas, such as handover performance, cell throughput, and timing.

¹⁹ Recreated from Table 5.12.1 of the 3GPP TS 34.121 Specifications

The frequency error specification specifies that the frequency error should be in the range of ± 0.1 ppm depending on the carrier frequency observed over a period of one timeslot compared to the carrier frequency received from the Node B. Thus, at a carrier frequency of 900 MHz the frequency error would be ± 90 Hz. Frequency error is critically important to avoid interference on the uplink and for successful decoding at the base station.

Error Vector Magnitude (EVM)

The error vector magnitude (EVM) measurement is one of the most common metrics of modulation quality because it captures the broadest range of transmitter impairments. EVM is measured by a VSA by first capturing an IQ waveform, and then demodulating the transmitted signal. Each recovered chip is then compared against the ideal chip locations. Both waveforms pass through a matched RRC filter with a bandwidth of 3.84 MHz and a roll-off of $\alpha=0.22$.

The measured chip location is given by the measured vector, m , as shown in **Figure 3.12**. However, the ideal chip location is given by v . Therefore, the resulting error vector is the difference between the actual measured and ideal vectors, or $e = m - v$, where e is the error vector, m is the measured chip location, and v is the ideal chip location. The error vector e for a received chip is graphically represented by **Figure 3.12**.

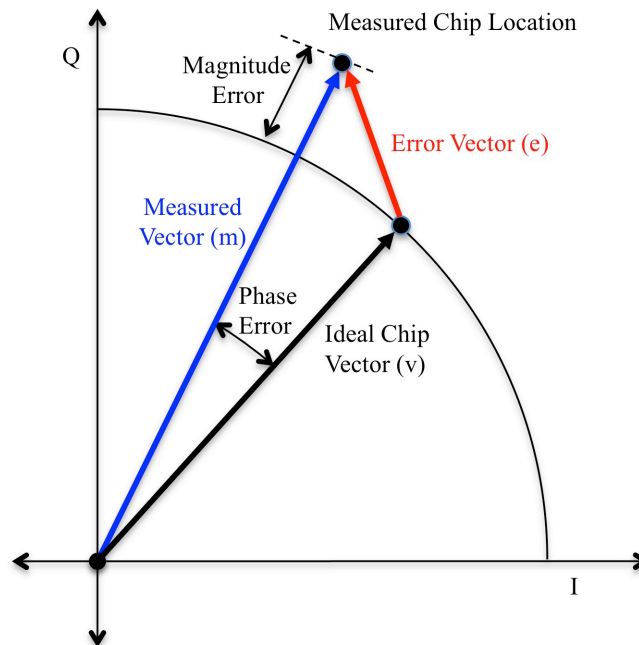

Figure 3.13. Graphical Representation of Error Vector and its Components

In Figure Y, and $\frac{e}{v}$ is the EVM. Although EVM quantifies the extent of the impairment, it does not necessarily reveal the source of error. To remove the dependence on system gain distribution, EVM is normalized by $|v|$, which is expressed as a percentage. Analytically, RMS EVM over a measurement window of N chips is defined by **Equation 3.1**.

$$EVM = \frac{\sqrt{\frac{1}{N} \sum_{j=1}^N [(I_j - \tilde{I}_j)^2 + (Q_j - \tilde{Q}_j)^2]}}{|V_{max}|}$$

Equation 3.1. RMS EVM Calculation Over N Symbols

In **Equation 2.2**, I_j is the I component of the j-th chip received, Q_j is the Q component of the j-th chip received, \tilde{I}_j is the ideal I component of the j-th chip received, \tilde{Q}_j is the ideal Q component of the j-th chip received. Section 5.13.1 of the 3GPP 34.121 specifications define EVM requirements for transmitters that vary according to the modulation scheme of the transmission. Although the initial UMTS release provided an EVM limit of 17.5%, 3GPP Release 7 introduced new requirements for the 16-QAM modulation scheme. EVM limits for each modulation scheme are illustrated in **Table 3.12**.

Modulation Scheme	EVM Limit	Power Level
QPSK	17.5%	≥ -20 dBm
16-QAM	14%	≥ -30 dBm

Table 3.12. EVM performance requirements of UMTS transmitters

Table 3.12 shows that UMTS transmitters are required to achieve the desired performance level above a specified power level, which is also illustrated in **Table 3.12**.

Techniques for Visualizing Modulation Quality

The two primary techniques to visualize EVM performance are through the EVM versus time trace and the constellation plot. **Figure 3.14**, shows EVM on a symbol by symbol basis. In this figure, the RMS EVM is 0.24% for the entire burst.

Introduction to UMTS Device Testing

Transmitter and Receiver Measurements for WCDMA Devices

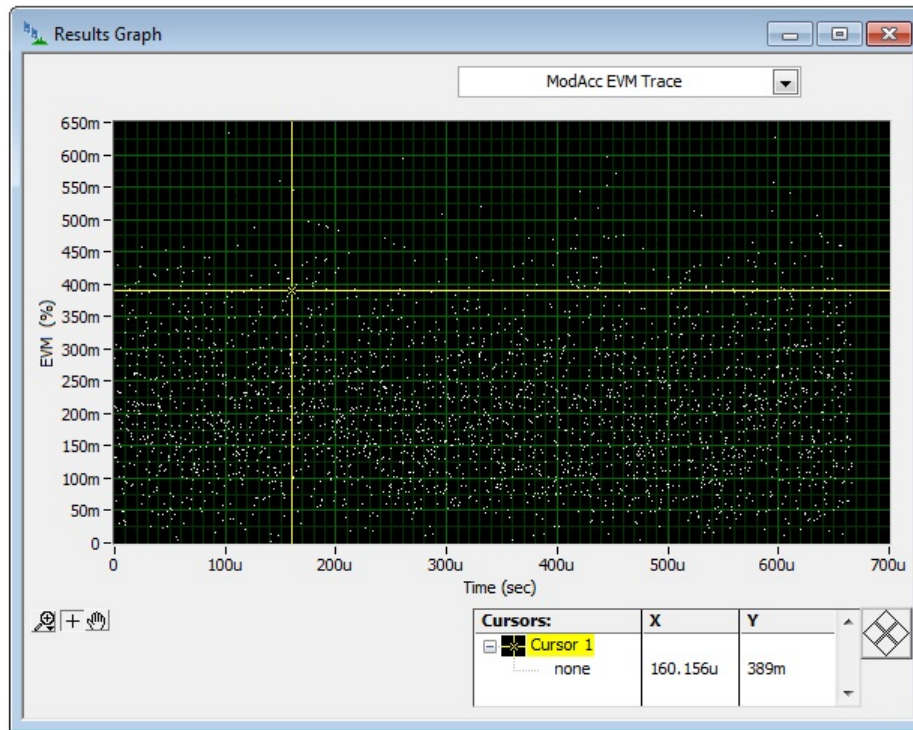

Figure 3.14. EVM as a function of time for a WCDMA transmission

Since a given WCDMA transmission contains a large number of chips, EVM is generally expressed as a RMS result. The WCDMA transmitter specifications require that the result is defined as the square root of the ratio of the mean error vector power to the mean reference power expressed as a percentage.

A second technique frequently used to troubleshoot issues with modulation accuracy is the constellation plot. The constellation plot is particularly useful when identifying whether a poor EVM result is due to poor performance of a transmitter or an inability of the test equipment to synchronize with the signal itself. An example constellation is illustrated in **Figure 3.15**.

Introduction to UMTS Device Testing

Transmitter and Receiver Measurements for WCDMA Devices

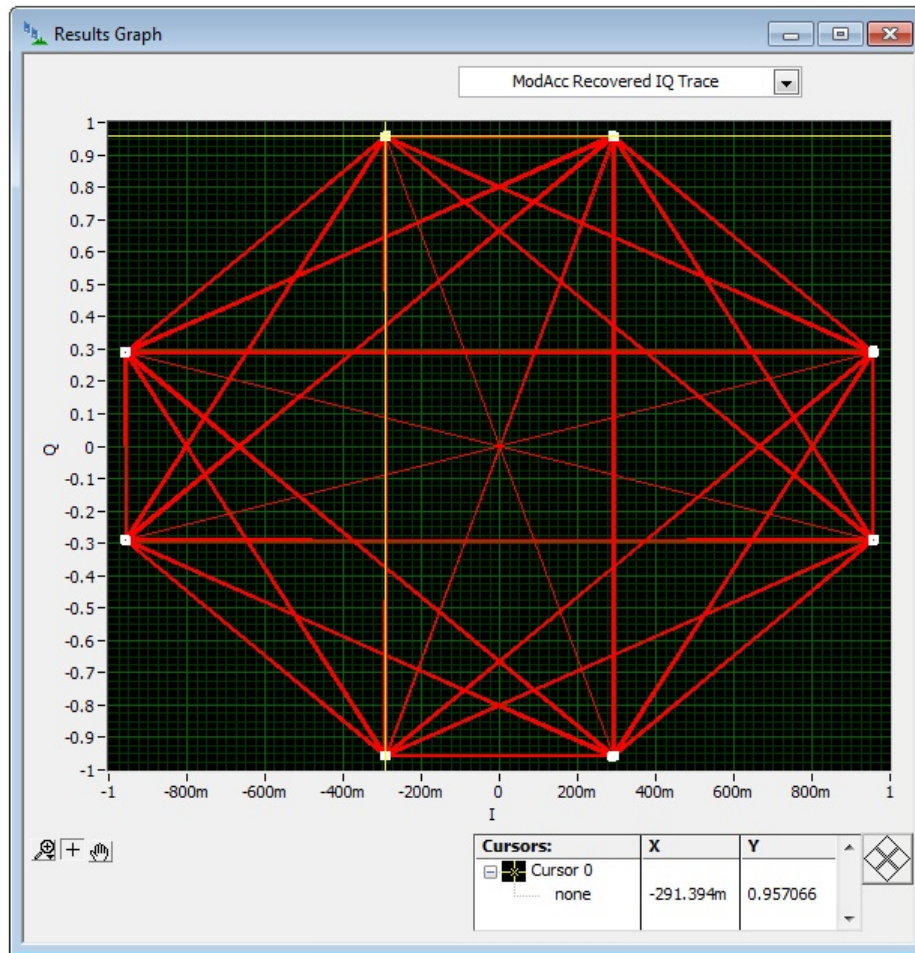

Figure 3.15 Constellation of UMTS Uplink Transmission

Peak Code Domain Error

EVM is not the only metric for determining the modulation quality of a WCDMA transmitter. Because WCDMA uses a spreading code to spread transmitted symbols on a wider bandwidth, for multi-code operation, the peak average ratio of the signal is increased as the signal for each code is summed, which places a much stricter linearity requirement on the power amplifier. As a result, the EVM measurement has been supplemented by another measurement called peak code domain error (PCDE), which specifies a limit for the error power resulting in any one code.

PCDE is defined by Section 5.13 of the 3GPP TS 34.121 specifications and is computed by projecting power of the error vector onto the code domain at a specific spreading factor (256 for example). The code domain error for every code in the domain is defined as the ratio of the mean power of the projection onto that code, to the mean power of the composite reference waveform expressed in dB. The PCDE is defined as the maximum value for the code domain error for all codes.

Introduction to UMTS Device Testing

Transmitter and Receiver Measurements for WCDMA Devices

3GPP Release 99 and 3GPP Release 4 specify a measurement interval for code domain error of one timeslot. However, 3GPP Release 5 and later releases clarify this measurement interval as being one timeslot except when the mean power between slots is expected to change, whereupon the measurement interval is reduced by 25 μ s at each end of the slot.

The requirements and this test apply only to the UE in which the multi-code DPDCH transmission is provided and therefore does not apply for the PRACH and PCPCH preamble and message parts for R99 and Release 4 only or the PRACH preamble and message parts for Release 5 and later.

The peak code domain error should not exceed -15 dB at a spreading factor 4 for the parameters specified in **Table 3.13**. The requirements are defined using the UL reference measurement channel (768 kbps) specified in clause C.2.5.

Parameter	Level / Status
Output power	≥ -20 dBm
Operating conditions	Normal conditions
Power control step size	1 dB

Table 3.13. Peak Code Domain Error Parameters²⁰

²⁰ Recreated from Table 5.13.3 of the 3GPP TS 34.121 Specifications

4. WCDMA Receiver Characteristics

In order to ensure that a receiver is consistently able to demodulate over-the-air transmissions from the base station, we must ensure that it is able to correctly receive signals in a wide range of operating conditions. Receiver measurements allow you to characterize the handset's ability to demodulate the over-the-air signal within a minimum bit error rate (BER). In general, the conditions described by the UMTS receiver specifications include scenarios such as low power levels, high power levels, and in the presence of interference.

UMTS receiver measurements are defined by Section 6 of the 3GPP TS 34.121 specifications and are illustrated in **Table 4.1**.

Measurement	3GPP TS 34.121 Section
Reference Sensitivity Level	6.2
Maximum Input Level	6.3
Adjacent Channel Selectivity	6.4
Blocking Characteristics	6.5
Spurious Response	6.6
Intermodulation Characteristics	6.7
Spurious Emissions	6.8

Table 4.1. UMTS Receiver Measurements

For receive chain components such as the LNA, there is a direct relationship between the noise figure (NF) of the LNA and the sensitivity of the device. As a result, metrics such as NF are most commonly used to characterize the behavior of the individual component, and sensitivity is a metric that is reserved to characterize the behavior of the receiver as a whole.

For the majority of receiver measurements, the primary receiver figure of merit is BER. The receiver characteristics measurements include reference sensitivity level, ACS, and blocking characteristics. The following section explains both the test setup and receiver requirements for each of these measurements.

Receiver Input Power Nomenclature

Although the UMTS receiver measurements are similar in many respects to that of GSM and LTE, the 3GPP TS 34.121 specifications uses specific nomenclature to describe the power of a WCDMA transmission. The downlink transmission in UMTS is based on the idea of transmitting multiple physical channels simultaneously in the same band through the use of distinct codes. The use of code division multiple access (CDMA) effectively allows for the simultaneous channelization of multiple physical channels.

When testing a UMTS receiver, the most important physical channel is the dedicated physical channel (DPCH). The DPCH carries user data from the base station to the UE, and the ability to demodulate it is a key characteristic of receiver performance. As a result, the code domain power of the DPCH E_c , is typically strictly defined by various UMTS receiver measurements.

A second key term for specifying receiver test conditions is the integrated power of the transmission. The UMTS specifications define the term 'I_{or}' to denote the power of the entire transmission in a 4.68 MHz (chip rate * 1 + α) bandwidth. As a reference, the following list defines each of these terms:

Introduction to UMTS Device Testing

Transmitter and Receiver Measurements for WCDMA Devices

- $DPCH_E_c$: Code domain power of the DPCH channel
- I_{or} : Integrated power of a UMTS transmission in a 3.84 MHz bandwidth
- $\frac{DPCH_E_c}{I_{or}}$: Ratio of DPCH code domain power to integrated power, typically -10 dB to -20 dB

Measuring Receiver BER

The fundamental metric of UMTS receiver performance is bit error rate (BER). With most UMTS receivers, there are two primary configurations to measure BER: loopback mode and single-ended mode.

Loopback Mode

When measuring BER in loopback mode, a vector signal generator (VSG) is configured to produce a downlink transmission at the desired output power, generally at a low power level. Internally, the UMTS receiver demodulates and decodes the downlink transmission and retransmits the same bitstream as an uplink transmission. A VSA will then demodulate and decode the re-transmitted bitstream. By comparing the “sent” bitstream with the “received” bitstream, you can calculate BER. **Figure 4.1** shows a block diagram of this approach.

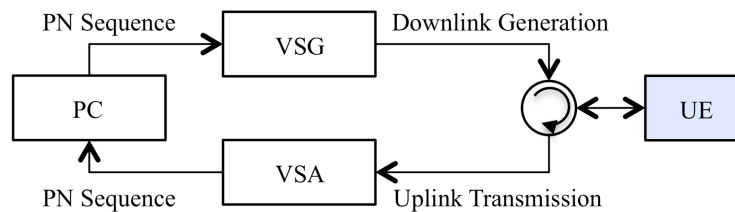

Figure 4.1. Block Diagram of Loopback Receiver BER Test Configuration.

When measuring BER in loopback mode, you typically configure the data pattern to be a pseudorandom (PN) binary sequence. The most common PN sequences used in BER measurements are PN9 and PN15, and the PN seed is defined by the 3GPP to ensure orthogonality between channels. These sequences are used quite widely for GSM receiver tests because their pseudorandom nature gives them a flat spectrum across the communication bandwidth, which is important for properly testing demodulation and decoding GSM receivers. In WCDMA, the randomization of the data stream is not as important as in GSM, because the data stream is already randomized by the scrambling sequence. However, the use of a PN sequence does benefit from autocorrelation properties, and as a result the BER measurement instrument doesn't need to be synchronized with the transmission of data on the DL. Thus, the BER can be calculated simply by autocorrelating the transmitted bitstream with the received bitstream.

Single-Ended Mode

A second and simpler approach is to configure the BER measurement in single-ended mode. Using this approach, configure the VSG to generate the appropriate UMTS downlink signal. Meanwhile, configure the receiver to internally calculate its BER and report the result to a PC using a digital interface such as USB. **Figure 4.2** shows a block diagram of the test setup.

Introduction to UMTS Device Testing

Transmitter and Receiver Measurements for WCDMA Devices

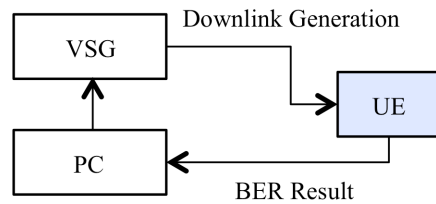

Figure 4.2. Block Diagram of a WCDMA BER Measurement

The primary benefit of the single-ended BER measurement is the simplicity of the test configuration. In addition, single-ended BER measurements are typically faster than the loopback mode and ultimately enable faster test times.

Reference Sensitivity Level

The reference sensitivity level is a fundamental metric of receiver performance and predicts the performance of the receiver in low signal strength conditions. Poor sensitivity decreases the coverage area in conditions where the receiver is relatively far from the base station. Sensitivity is defined as the lowest average power level at the UE antenna port for which the receiver can achieve a particular maximum BER. Specifically for WCDMA, the maximum BER for a sensitivity measurement is 0.001 (0.1%).

When testing sensitivity, configure a VSG to produce a relatively low power transmission. The power level of the downlink signal is specified in terms of the DPCH code domain power (DPCH_{E_c}) and the total received power of the WCDMA signal, also known as \hat{I}_{or} . **Table 4.1** shows that the minimum sensitivity requirements of a UMTS receiver vary slightly according to operating band.

Operating Band	Unit	DPCH_Ec </REFSENS>	<REFI _{or} >
I	dBm/3.84 MHz	-117	-106.7
II	dBm/3.84 MHz	-115	-104.7
III	dBm/3.84 MHz	-114	-103.7
IV	dBm/3.84 MHz	-117	-106.7
V	dBm/3.84 MHz	-115	-104.7
VI	dBm/3.84 MHz	-117	-106.7
VII	dBm/3.84 MHz	-115	-104.7
VIII	dBm/3.84 MHz	-114	-103.7
IX	dBm/3.84 MHz	-116	-105.7

Table 4.1. Sensitivity Requirements for UMTS Receivers by Operating Band²¹

The minimum sensitivity requirements define a power level according to the DPCH and \hat{I}_{or} characteristics. For example, in operating band I, the absolute power on the data channel DPCH is specified as $DPCH_{Ec} = -117$ dBm/3.84 MHz. Here, the $DPCH_{Ec}$ definition describes the spectral power density of the DPCH channel. The total power of the WCDMA signal, \hat{I}_{or} , is indicated as -106.7 dBm. As described earlier, \hat{I}_{or} is strictly defined as the power level in a 3.84 MHz bandwidth. You can perform the sensitivity test in two ways. The first and quickest method is to configure the VSG to the sensitivity limit and then measure the BER. If the BER is below 0.1%, the device passes. In some cases, it is useful to measure the power level at which the receiver crosses the 0.1% BER threshold. In this case, gradually reduce the power until the receiver reaches the 0.1% BER threshold.

Maximum Input Level

Just as a WCDMA receiver experiences degraded performance at sufficiently low power levels due to poor signal to noise ratio, its performance also degrades at higher power levels due to the non-linear behavior of the receiver. As a result, the maximum input level is an important specification that is designed to ensure that the receiver will maintain a sufficient BER even in scenarios where it is closer to the base station.

The maximum input level specification is defined as the maximum mean power received at the UE antenna port for which a receiver does not exceed a BER of 0.001 (0.1%). Testing BER is identical to that of sensitivity except that the power level of the transmission is at a high power level rather than a low one. Similar to reference sensitivity level, the maximum input level is defined in terms of the DPCH code domain power ($DPCH_{Ec}$) and the total power of the WCDMA signal in a 3.84 MHz bandwidth, or \hat{I}_{or} . **Table 4.2** defines these power levels.

²¹ Recreated Table 6.2.1 of the 3GPP TS 34.121 Specifications

Parameter	Level
\hat{I}_{or}	-25 dBm / 3.84 MHz
$\frac{DPCH_{Ec}}{I_{or}}$	-19 dB

Table 4.2. Maximum Input Requirements for UMTS Receivers²²

Table 4.2 shows that the maximum input power level for a UMTS UE receiver is -25 dBm measured in 3.84 MHz bandwidth. When testing maximum input level, the VSG must be configured to a power level of -25 dBm with the DPCH channel set to -19 dB relative to the total power of the transmission.

The test setup configuration for maximum input level is identical to that of reference sensitivity. To measure BER, configure the handset either in loopback or single-ended mode. In order to pass the maximum input power requirements the receiver should not exceed a BER of 0.1%.

Adjacent Channel Selectivity (ACS)

Adjacent channel selectivity (ACS) is a measure of a receiver's ability to suppress out-of-band interfering signals that occur in the channel's adjacent channel. Ideally, the UE should limit the signal to the 5 MHz assigned channel and completely reject all out-of-channel energy. However this is not always true in practice. ACS is the maximum ratio of the power in the assigned channel frequency to the power in the adjacent channel for which the receiver sensitivity is 3 dB worse than its nominal sensitivity specification. A receiver with poor ACS would experience a decreasing coverage area when other transmitters exist in the adjacent channel.

When testing ACS, two VSGs and a power combiner are required to produce a stimulus to the DUT. In addition, depending on how one is measuring BER (loopback or single-ended) a VSA may also be required. Figure 4.3 shows a typical test configuration using the single-ended BER measurement approach.

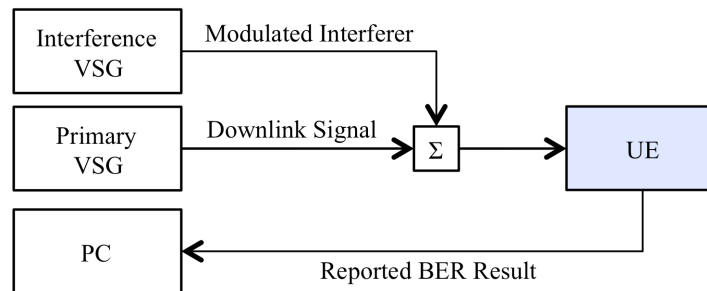

Figure 4.3. Test Setup for UMTS Receiver Adjacent Channel Selectivity

²² Recreated Table 6.3.2 of the 3GPP TS 34.121 Specifications

Figure 4.3 shows that the primary VSG produces a WCDMA downlink signal in the assigned center frequency of the receiver. The interference VSG is configured to produce a high power downlink signal at a center frequency that is offset by either -5 MHz or +5 MHz from the primary VSG.

The outputs of both the primary downlink VSG and the interfering VSG are combined with a combiner, and the output is introduced to the handset. When using this configuration, it is important to calibrate for the insertion loss introduced in the combiner. Insertion losses in the range of 3 dB (ideal) to 3.5 dB (typical) are common using a standard 2-port combiner. As a result, you must carefully calibrate the insertion loss of the combiner and compensate for it by adjusting the power level of the RF VSGs accordingly. **Table 4.3** defines the power levels of the reference and interference signal required for the ACS measurement.

Parameter	Level / Status
DPCH_Ec	-103 dBm/3.84 MHz
\hat{I}_{or}	-92.7 dBm/3.84 MHz
Interferer Average Power	-52 dBm
Interferer Frequency Offset	-5/+5 MHz
UE transmitted mean power	+20 dBm (for Power class 3) +18 dBm (for Power class 4)

Table 4.3. Test Parameters for Adjacent Channel Selectivity for Release 99 and Release 4²³

Table 4.3 shows that the power level of the primary (or reference) VSG includes an element of the DPCH code domain power (DPCH_Ec) and the total transmitted power in a 3.84 MHz bandwidth (\hat{I}_{or}). In order to pass the ACS measurement requirements, the receiver must achieve a BER of better than 0.001 (0.1%) for the parameters specified in **Table 4.3**.

Blocking Characteristics

The blocking characteristic is a measure of the receiver's ability to appropriately demodulate a WCDMA signal in the presence of a wide range of interference and generally high-power signals. While this is similar to ACS in some respects, the blocking characteristics defines receiver performance for an interfering signal that can occur over a much broader range of frequencies than just the neighboring channels. Blocking characteristics is divided into three categories: in-band blocking, out-of band blocking, and narrowband blocking.

Blocking characteristics measurements require both continuous wave (CW) interfering signal and a modulated interfering signal though not concurrently. A VSG with the capability to be put in both vector and CW mode is sufficient to perform blocking characteristic measurements. The blocking characteristics measurements specify a range of blocking signals that include CW signals close to the band of interest (narrowband blocking), CW signals

²³ Recreated Table 6.4.1 of the 3GPP TS 34.121 Specifications

Introduction to UMTS Device Testing

Transmitter and Receiver Measurements for WCDMA Devices

farther from the band of interest (out-of-band blocking), and modulated signals relatively close the band of interest (in-band blocking). **Figure 4.4** illustrates a visual representation of these blocking signals.

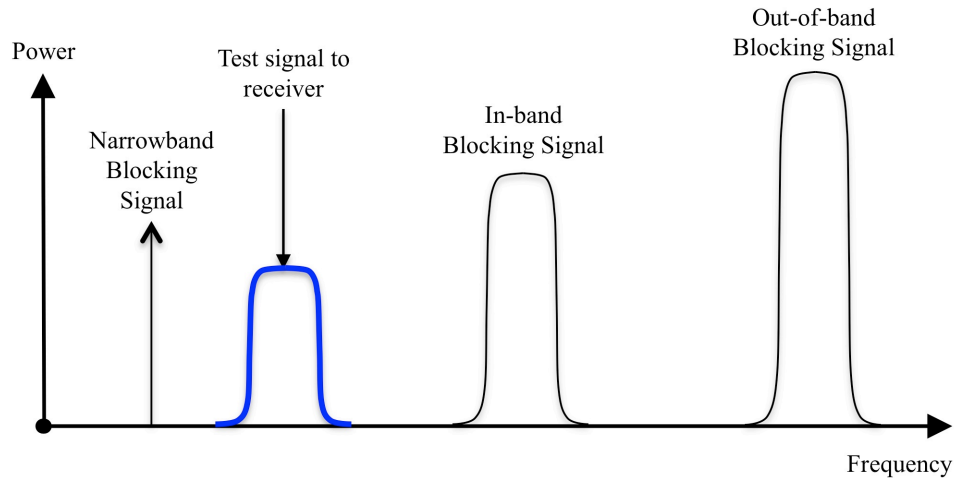

Figure 4.4. Types of UMTS Blocking Signals

When testing blocking characteristics, two VSGs are used. The primary (or reference) VSG produces a UMTS downlink signal that is demodulated by the receiver. The interfering VSG then produces either a modulated or CW interferer at the specified frequency. **Figure 4.5** shows a typical test configuration with the receiver set up in a single-ended BER configuration.

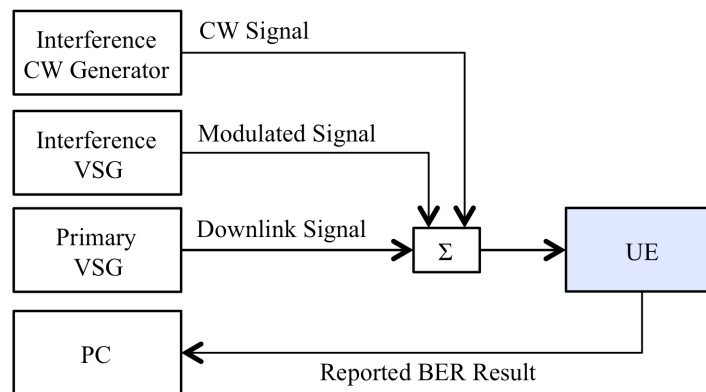

Figure 4.5 Test Configuration for Blocking Characteristics Measurement

Again, the primary metric to evaluate receiver performance is BER, and the maximum BER is 0.1% with the interfering signals present.

In-Band Blocking

In-band blocking defines receiver performance in the presence of interferers within a frequency range that is within the UE's operating band. In-band blocking is defined for an unwanted modulated interfering signal falling into the UE receive band that is within 15 MHz below or above the UE receive channel, as illustrated in **Figure 4.6**.

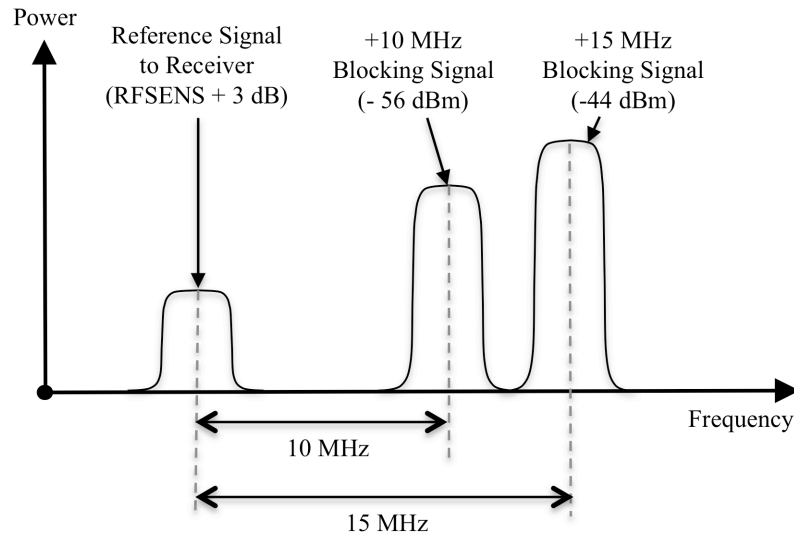

Figure 4.6. Frequency Domain View of In-band Blocking Signal at Receiver

The in-band blocking requirements specify the power level of the interfering signal at a range of power levels and frequency offset. For example, interferers at ± 15 MHz are higher in power than interferers at ± 10 MHz relative to the center frequency. According to the 3GPP TS 34.121 specifications, the receiver must be able to achieve the 0.1% BER with interfering signals present at a reference power level that is 3 dB above the sensitivity limit.

When performing an in-band blocking measurement, the primary VSG is configured to produce a WCDMA signal at a relatively low power level that is 3 dB above the reference sensitivity level. Also, the power level of the modulated interferer is dependent on the frequency offset, as shown in **Table 4.4**.

Parameter	Unit	Level	
DPCH Ec	dBm/3.84 MHz	<REFSENS>+3 dB	
I _{or}	dBm/3.84 MHz	<REFI _{or} > + 3 dB	
I _{blocking} mean power	dBm	-56	-44
F _{uw} offset	MHz	= ±10	≤-15 & ≥15
F _{uw} (Band I operation)	MHz	2102.4 ≤ f ≤ 2177.6	2095 ≤ f ≤ 2185
F _{uw} (Band II operation)	MHz	1922 ≤ f ≤ 1997.6	1915 ≤ f ≤ 2005
F _{uw} (Band III operation)	MHz	1797 ≤ f ≤ 1887.6	1790 ≤ f ≤ 1895
F _{uw} (Band IV operation)	MHz	2102.4 ≤ f ≤ 162.6	2095 ≤ f ≤ 2170
F _{uw} (Band V operation)	MHz	861.4 ≤ f ≤ 901.6	854 ≤ f ≤ 909
F _{uw} (Band VI operation)	MHz	867.4 ≤ f ≤ 892.6	860 ≤ f ≤ 900
F _{uw} (Band VII operation)	MHz	2612.4 ≤ f ≤ 697.6	2605 ≤ f ≤ 2705
F _{uw} (Band VIII operation)	MHz	917.4 ≤ f ≤ 967.6	910 ≤ f ≤ 975
F _{uw} (Band IX operation)	MHz	1837.4 ≤ f ≤ 1887.4	1829.9 ≤ f ≤ 1894.9
UE Mean Power	dBm	+20 (for Power class 3) +18 (for Power class 4)	

Table 4.4. Spectrum of Input Signal for In-band Blocking Characteristics²⁴

Table 4.4 shows that the in-band blocking requirements specify a range of frequencies for the interfering signal that are dependent on the operating band of the receiver. In general, you are required to test the receiver only for the operating bands of the receiver.

Out-of-Band Blocking

Out-of-band band blocking is defined for an unwanted CW interferer signal falling more than 15 MHz below or above the UE receive band. Out-of-band blocking accounts for general interference that occurs anywhere outside of the operating band of the receiver. When measuring out-of-band blocking, configure the interfering VSG to produce a CW output. Meanwhile, similar to other blocking characteristics measurements, the primary VSG produces the reference signal for the receiver to demodulate a signal 3 dB above the reference sensitivity level.

The power level of the CW interfering signal in out-of-band blocking is dependent upon the frequency offset from the receiver, as illustrated in **Figure 4.7**.

²⁴ Recreated Table 6.5.1 of the 3GPP TS 34.121 Specifications

Introduction to UMTS Device Testing

Transmitter and Receiver Measurements for WCDMA Devices

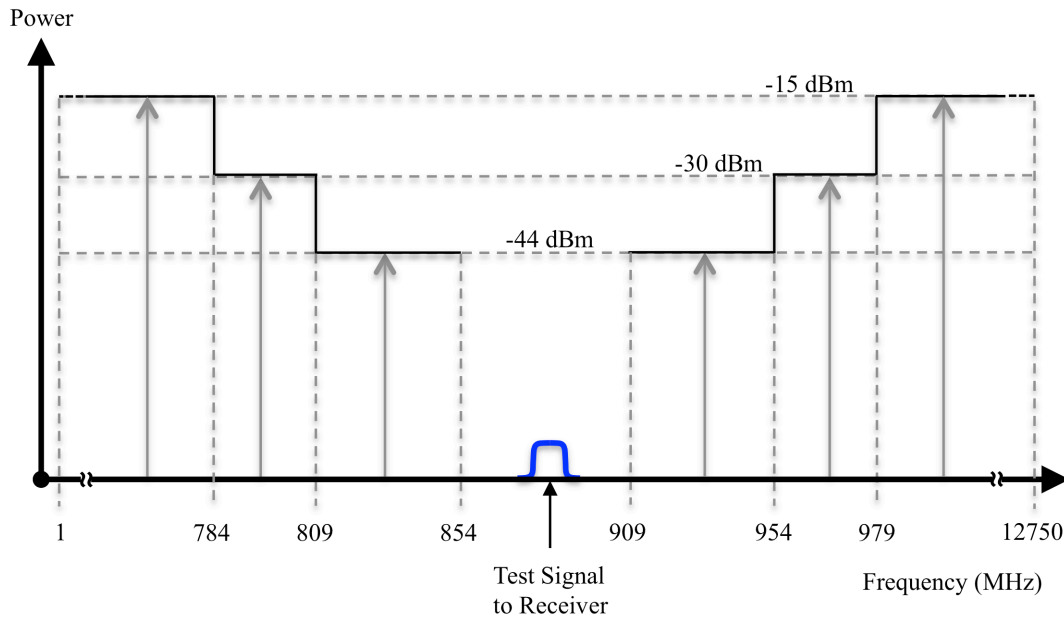

Figure 4.7. Power Levels and Frequency Offsets of Out-of-band Blocking Characteristics for UMTS Band V

Figure 4.7 shows that the primary VSG produces a reference signal and the interfering VSG produces a blocking signal at a range of power levels and frequency offsets. The close-in interferers are lower in power than far out interferers. Depending on the actual frequency, the power of the CW interfering signal ranges between -44 dBm and -15 dBm, whereas the useful signal power level is only 3 dB above the reference sensitivity level of the UE receiver. **Table 4.5** defines the specific power levels for the CW interferer.

Parameter	Unit	Frequency Range 1	Frequency Range 2	Frequency Range 2
DPCH_Ec	dBm/3.84 MHz	<REFSENS>+3 dB	<REFSENS>+3 dB	<REFSENS>+3 dB
I _{or}	dBm/3.84 MHz	<REFI _{or} > + 3 dB	<REFI _{or} > + 3 dB	<REFI _{or} > + 3 dB
I _{blocking} mean power (CW)	dBm	-44	-30	-15
F _{uw} (Band I operation)	MHz	2050<f <2095 2185<f <2230	2025 <f ≤2050 2230 ≤f <2255	1 < f ≤2025 2255≤f<12750
F _{uw} (Band II operation)	MHz	1870<f <1915 2005<f <2050	1845 <f ≤1870 2050 ≤f <2075	1 < f ≤1845 2075≤f<12750
F _{uw} (Band III operation)	MHz	1745 <f <1790 1895<f <1940	1745 <f <1790 1895<f <1940	1 < f ≤1720 1965≤f<12750
F _{uw} (Band V operation)	MHz	809 <f <854 909< f <954	784< f ≤809 954≤ f < 979	1 < f ≤784 979≤f<12750
F _{uw} (Band VI operation)	MHz	815 < f < 860 900 < f < 945	790 < f ≤ 815 945 ≤ f < 970	1 < f ≤ 790 970 ≤ f < 12750
F _{uw} (Band VII operation)	MHz	1784.9 < f < 1829.9 1894.9 < f < 1939.9	1759.9 < f ≤ 1784.9 1939.9 ≤ f < 1964.9	1 < f ≤ 1759.9 1964.9 ≤ f < 12750
UE Mean Power	dBm		+20 (for Power class 3) +18 (for Power class 4)	

Table 4.5. Out-of-band Blocking Characteristics Interferer Characteristics²⁵

According to Section 6.5.2.2 of the 3GPP 34.121 specifications, the receiver must be able to achieve the 0.1% BER at a power level that is 3 dB higher than its reference sensitivity level for the parameters specified in **Table 4.5** for frequencies up to 1.275 GHz.

Narrowband Blocking

The final blocking measurement is narrowband blocking, which measures the receiver's ability to demodulate a UMTS signal in the presence of an unwanted narrowband interferer at a frequency less than the nominal channel spacing. With narrowband blocking characteristics, the interfering signal designed to mimic a GSM transmission use the GMSK modulation scheme. **Figure 4.8** shows that the GMSK interferer is placed at a frequency that is offset by either 2.7 MHz or 2.8 MHz from the receiver channel.

²⁵ Recreated Table 6.5.2 of the 3GPP TS 34.121 Specifications

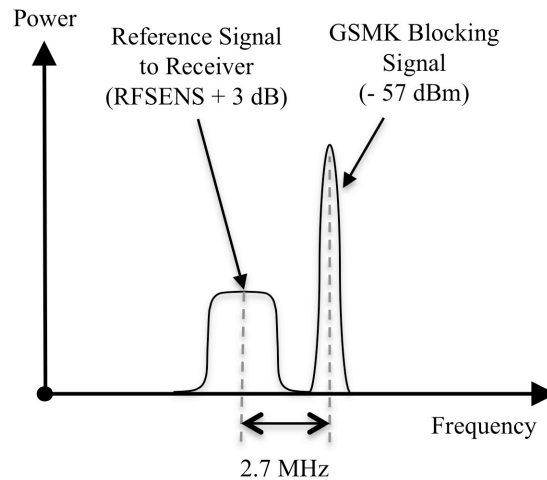

Figure 4.8. Frequency Domain of Narrowband Blocking Characteristics for Band II and V

When measuring narrowband blocking, configure two VSGs to produce a modulated signal. The primary VSG produces a UMTS downlink signal that is 10 dB above the sensitivity level of the UE. In addition, **Table 4.6** shows that the interfering VSG produces a modulated signal at a power level of -57 dBm for Bands II, IV and V, and at a power level of -56 dBm for Bands III and VIII.

Parameter	Unit	Band II, Band IV and Band V	Band III, VIII
DPCH_Ec	dBm/3.84 MHz	<RFSSENS> + 10 dB	<RFSSENS> + 10 dB
I _{or}	dBm/3.84 MHz	<REFI _{or} > + 10 dB	<REFI _{or} > + 10 dB
I _{blocking} (GMSK)	dBm	-57	-56
F _{uw} (offset)	MHz	2.7	2.8
UE transmitted mean power	dBm	+20 (for Power class 3) +18 (for Power class 4)	

Table 4.6. Spectrum of Input Signal for Narrowband Blocking Characteristics²⁶

Similar to in-band and out-of-band blocking characteristics, the narrow-band blocking measurement requires the UE to not exceed 0.1% BER under the condition described in **Table 4.6**.

Spurious Response

Spurious response is a measure of the receiver's ability to receive a wanted signal on its assigned channel frequency without exceeding a given degradation due to the presence of an unwanted CW interfering signal. In addition, the

²⁶ Recreated from Table 6.5.6 of the 3GPP TS 34.121 Specifications

Introduction to UMTS Device Testing

Transmitter and Receiver Measurements for WCDMA Devices

spurious response conditions apply specifically to frequencies for which a device has failed the out-of-band blocking requirements.

Thus, before testing for spurious responses, first test a receiver for out-of-band blocking and record the interference frequencies for which the device failed the out-of-band blocking requirements. Under the spurious response requirements, the device must still achieve less than 0.1% BER, but under relaxed interference criteria versus out-of-band blocking.

The test hardware configuration for spurious response is identical to out-of-band blocking and requires a VSG, a CW signal generator, and a power combiner as shown in **Figure 4.9**.

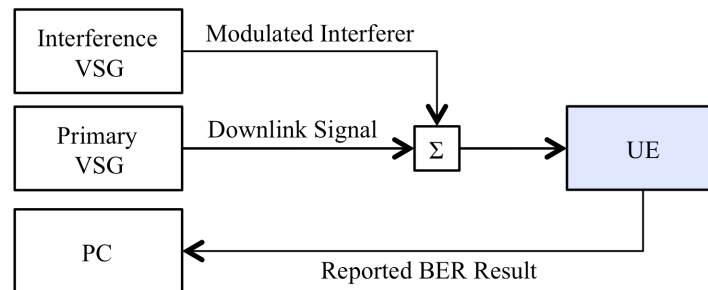

Figure 4.9. Test Configuration for Spurious Response Measurement

Figure 4.9 shows the VSG producing a WCDMA downlink signal that is 3 dB above the reference sensitivity of the receiver. In this setup, configure the CW generator according to the power levels specified in **Table 4.7**

Parameter	Level	Unit
DPCH_Ec	<REFSENS> + 10 dB	dBm / 3.84 MHz
I _{or}	<REFI _{or} > + 10 dB	dBm / 3.84 MHz
I _{blocking} (CW)	-44	dBm
F _{uw}	Spurious response frequencies	MHz
UE transmitted mean power	20 (for Power class 3) 18 (for Power class 4)	dBm

Table 4.7 Specification Limits for Spurious Response Measurement²⁷

The lack of the spurious response ability decreases ability of a receiver to demodulate the downlink signal in the presence of nearby interference signals.

²⁷ ²⁷ Recreated from Table 6.6.1 of the 3GPP TS 34.121 Specifications

Intermodulation Characteristics

Intermodulation products are caused by nonlinear behaviors of various receiver components such as amplifiers and mixers. The result of third and higher order mixing of two interfering RF signals can produce an interfering signal in the band of the desired channel. The UMTS intermodulation characteristics requirement measures the ability of the receiver to receive a wanted signal on its assigned channel frequency in the presence of two or more interfering signals that have the potential to create an interfering intermodulation product.

When measuring intermodulation characteristics, the frequency spacing of the two interfering signals is chosen such that they produce a third-order distortion product that directly interferes with the reference signal. Thus, the frequency offset between the CW interferer and the modulated interferer is equivalent to the frequency spacing between the CW interferer and the reference signal to the receiver. **Figure 4.10** illustrates that the resulting third-order distortion product directly interferes with the reference signal.

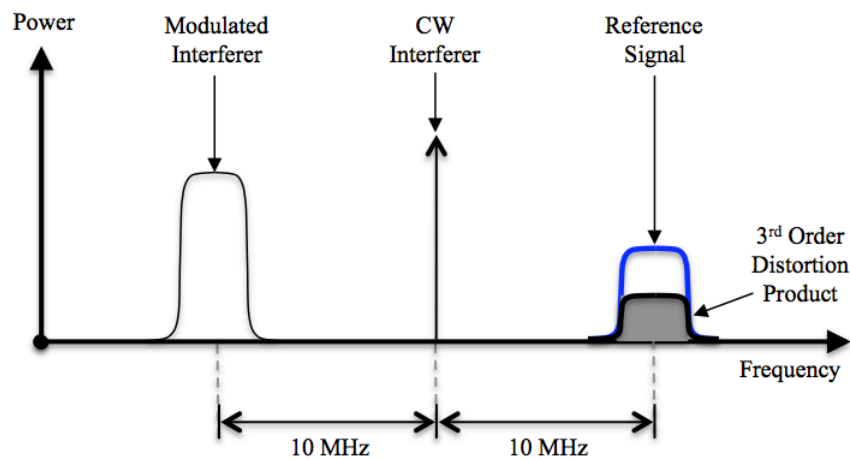

Figure 4.10. Interfering CW and Modulated Interferers Produce Third-order Distortion Products

The intermodulation characteristics measurement requires multiple signal generators to produce interference signal as well as the test signal to the DUT. The test setup includes two VSGs and one CW signal generator. As a result, the hardware configuration requires a three-way RF power combiner. The combined output is then connected to the DUT as illustrated in **Figure 4.11**.

Introduction to UMTS Device Testing

Transmitter and Receiver Measurements for WCDMA Devices

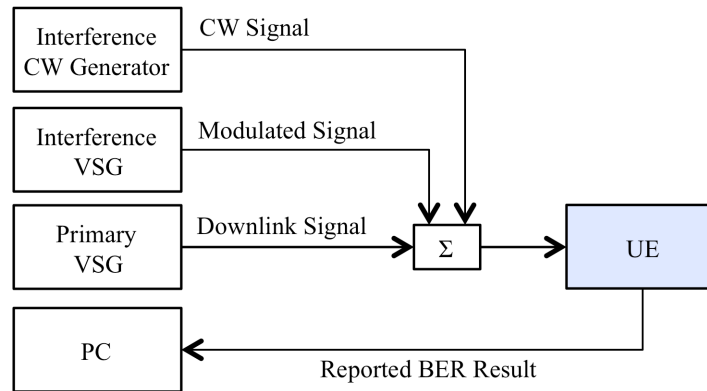

Figure 4.11. Instrument Test Configuration for Intermodulation Characteristics Measurement

Figure 4.11 illustrates that the frequency spacing between interfering tones is precisely chosen in order to produce a third-order distortion product at the appropriate frequency.

The UMTS intermodulation characteristics measurement defines two specific intermodulation scenarios, one for WCDMA intermodulation and the other for GSM intermodulation. For example, **Table 4.8** describes both the power levels and tone spacing for interfering signals for intermodulation due to a WCDMA interferer.

Parameter	Level	Unit
DPCH_Ec	<REFSENS> + 3 dB	dBm / 3.84 MHz
I _{or}	<REFI _{or} > + 3 dB	dBm / 3.84 MHz
I _{ouw1} (CW)	-46	dBm
I _{ouw2} mean power (modulated)	-46	dBm
F _{uw1} (offset)	10 -10	MHz
F _{uw2} (offset)	20 -20	MHz
UE transmitted mean power	+20 (for Power class 3) +18 (for Power class 4)	dBm

Table 4.8. Intermodulation Due to WCDMA Interferer²⁸

Table 4.8 shows the frequency spacing between the CW and WCDMA products is 10 MHz, and the CW is offset from the reference channel by an equivalent frequency spacing of 10 MHz. The UMTS reference signal is configured to a power level that is 3 dB above the sensitivity limit of the receiver.

By contrast, **Table 4.9** illustrates the similar requirements for a GSM transmission. Here, the CW and GSMK interferer are spaced at either 3.5 MHz or 3.6 MHz, depending on the band of operation. Unlike **Table 4.8**, the

²⁸ Recreated from Table 6.7.1 of the 3GPP TS 34.121 Specifications

UMTS reference signal is configured to a power level that is 10 dB above the sensitivity limit of the receiver when testing for the GSMK intermodulation condition.

Parameter	Unit	Band II, Band IV and Band V		Band III, VIII	
DPCH_Ec	dBm/3.84 MHz	<REFSENS> + 10 dB		<REFSENS> + 10 dB	
I _{or}	dBm/3.84 MHz	<REFI _{or} > + 10 dB		<REFI _{or} > + 10 dB	
I _{ouw1} (CW)	dBm	-44		-43	
I _{ouw2} (GMSK)	dBm	-44		-43	
F _{uw1} (offset)	MHz	3.5	-3.5	3.6	-3.6
F _{uw2} (offset)	MHz	5.9	-5.9	6.0	-6.0
UE transmitted mean power	dBm	20 (for Power class 3) 18 (for Power class 4)			

Table 4.9. Intermodulation Due to GSM Interferer²⁹

Finally, similar to other receiver measurements, the UMTS receiver must achieve a BER that is better than 0.001 (0.1%) under the conditions described above.

Spurious Emissions

The final UMTS receiver measurement is spurious response, which characterizes the out-of-band emissions of the receiver. Unlike the spurious response measurement, which characterizes the receiver's ability to demodulate a signal in the presence of interference, the spurious emissions measurement characterizes the transmitted emissions of the receiver itself. Although a receiver is generally designed to not transmit signals at all, issues such as a local oscillator coupling onto the antenna port can result in unwanted emissions.

When testing spurious emissions, connect a spectrum analyzer directly to the receiver port of the DUT. **Figure 4.12** shows the spectrum analyzer connected to the DUT through a circulator.

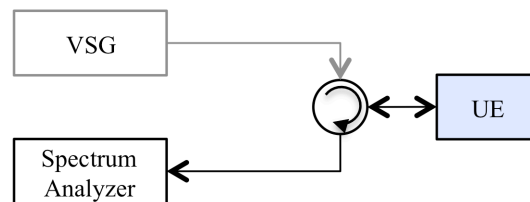

Figure 4.12 Spurious Emissions Measurement with a Spectrum Analyzer

Table 4.10 shows that the receiver emissions is measured using one of two measurement bandwidth configurations with varying maximum emissions levels. For example, receiver emissions cannot exceed -57 dBm in a 100 kHz

²⁹ Recreated from Table 6.7.2 of the 3GPP TS 34.121 Specifications

Introduction to UMTS Device Testing

Transmitter and Receiver Measurements for WCDMA Devices

bandwidth when operating at a center frequency less than 1 GHz. In addition, the emissions cannot exceed -47 dBm in a 1 MHz bandwidth at a center frequency greater than 1 GHz.

Frequency Band	Measurement Bandwidth	Maximum Level
$30 \text{ MHz} \leq f < 1 \text{ GHz}$	100 kHz	-57 dBm
$1 \text{ GHz} \leq f \leq 12.75 \text{ GHz}$	1 MHz	-47 dBm

*Table 4.10. Spurious emissions requirement*³⁰

The limits described in **Table 4.10** are established to ensure that the receiver doesn't interfere with other cellular and wireless devices. Although the emissions requirements for UMTS transmitters are rigidly defined, the only emissions requirement for UMTS receivers is spurious emissions.

³⁰ Recreated from Table 6.8.1 of the 3GPP TS34.121 Specifications

5. References

1. 3GPP TS 25.101: "UE Radio transmission and reception (FDD)".
2. 3GPP TS 25.133: "Requirements for Support of Radio Resource Management (FDD)".
3. 3GPP TS 34.108: "Common Test Environments for User Equipment (UE) Conformance Testing".
4. 3GPP TS 34.109: "Terminal logical test interface; Special conformance testing functions".
5. 3GPP TS 25.214: "Physical layer procedures (FDD)".
6. 3GPP TR 21.905: "Vocabulary for 3GPP Specifications".
7. 3GPP TR 25.990: "Vocabulary".
8. 3GPP TS 25.331: "Radio Resource Control (RRC); Protocol Specification".
9. 3GPP TS 25.433: "UTRAN Iub Interface NBAP Signalling".
10. ITU-R Recommendation SM.329: "Spurious emissions".
11. 3GPP TS 25.304: "UE Procedures in Idle Mode and Procedures for Cell Reselection in Connected Mode".
12. 3GPP TS 25.303: "Interlayer Procedures in Connected Mode".
13. 3GPP TS 25.321: "Medium Access Control (MAC) protocol specification".
14. 3GPP TS 25.213: "Spreading and modulation (FDD)".
15. 3GPP TS 25.223: "Spreading and modulation (TDD)".
16. ETSI ETR 273-1-2: "Improvement of radiated methods of measurement (using test sites) and evaluation of the corresponding measurement uncertainties; Part 1: Uncertainties in the measurement of mobile radio equipment characteristics; Sub-part 2: Examples and annexes".
17. 3GPP TR 25.926: "UE Radio Access Capabilities".
18. 3GPP TR 21.904: "UE capability requirements".
19. 3GPP TS 25.211: "Physical channels and mapping of transport channels onto physical channels (FDD)".
20. 3GPP TS 05.08 (R99): "Technical Specification Group GSM/EDGE Radio Access Network; Radio subsystem link control".
21. 3GPP TS 34.123-1: "User Equipment (UE) Conformance Specification; Part 1: Protocol Conformance Specification".
22. 3GPP TS 25.215: "Physical Layer - Measurements (FDD)".
23. 3GPP TR 34.902: "Derivation of test tolerances for multi-cell Radio Resource Management (RRM) conformance tests".
24. 3GPP TS 51.010-1: "Mobile Station (MS) conformance specification; Part 1: Conformance specification".
25. 3GPP TS 25.307 "Requirements on UEs supporting a release independent frequency band".

Introduction to UMTS Device Testing

Transmitter and Receiver Measurements for WCDMA Devices

26. ITU-T recommendation O.153: "Basic parameters for the measurement of error performance at bit rates below the primary rate".
27. 3GPP TS 05.05 (R99): "Technical Specification Group GSM/EDGE Radio Access Network; Radio transmission and reception".
28. 3GPP TS 45.005 (Rel-4 and later releases): "Technical Specification Group GSM/EDGE Radio Access Network; Radio transmission and reception".
29. 3GPP TS 45.008 (Rel-4 and later releases): "Technical Specification Group GSM/EDGE Radio Access Network; Radio subsystem link control".
30. 3GPP TS 25.212: "Multiplexing and channel coding (FDD)".
31. 3GPP TS 34.121-2: "User Equipment (UE) conformance specification; Radio transmission and reception (FDD); Part 2: Implementation Conformance Statement (ICS)".
32. 3GPP TS 36.508: "Technical Specification Group Radio Access Network; E-UTRA and EPC; Common test environments for User Equipment (UE)".³ Definitions, symbols, abbreviations and equations
33. 3GPP TS 36.133: "E-UTRA requirements for support of radio resource management".
34. 3GPP TS 36.211: "Physical Channels and Modulation".
35. 3GPP TS 36.331: "E-UTRA Radio Resource Control (RRC): protocol specification".
36. 3GPP TS 36.101: "E-UTRA UE radio transmission and reception".
37. 3GPP TS 36.521-3: "Evolved Universal Terrestrial Radio Access (E-UTRA); User Equipment (UE) conformance specification; Radio transmission and reception; Part 3: Radio Resource Management (RRM) conformance testing".